



# Valves

 **MATCO-NORCA**  
Global sourcing. National compliance. Local service.

C A L I F O R N I A   •   T E X A S   •   N E W   Y O R K

# Table of Contents

## ITEM NAME PAGE NUMBER

**A**  
 Angle Control Valve .....15  
 Angle Valve .....20, 29, 33  
 Aztec Boiler Drain .....22  
 Aztec Garden Valve .....22  
 Aztec Hose Bibb .....22, 24  
 Aztec Low Pressure Valves .....22-24  
 Aztec Sillcocks .....23

**B**  
 Back Flow Preventers .....22  
 Balancing Valves .....34  
**Ball Valves**

Carbon Steel .....39, 40, 42  
 Compression Ends .....7  
 CPVC .....11  
 CSA .....4-5  
 Drop Ear .....7  
 Full Port .....4-7  
 Gas .....8  
 Heavy Duty .....5  
 Hose Bibb .....25  
 Locking Handles .....4  
 Long Bonnet .....6  
 Male X Female .....4, 7  
 Nickel Plated .....5-6  
 One Piece .....5  
 Pex Ends .....7  
 Press .....5  
 PVC .....10-11  
 SS Cross Handles .....6  
 SS Thumb Grip Handles .....4  
 Stainless Steel .....5, 39-41  
 Standard Port .....5-7  
 Tee Handles .....4  
 UL/FM .....4-5  
 Uni-Flange .....7  
 UPC .....4  
 With Waste Drain .....7  
 Blind Flanges .....56

### Boiler Drains

Aztec .....22  
 Brass .....21  
 Bolt & Gasket Sets .....57  
 Bolts .....57, 58

### Butterfly Valves

B1 - PVC Wafer Style .....61  
 B1 - Parts .....61  
 B5 - Wafer Style .....62  
 B5 - Lug Style .....62  
 B5 - Parts .....63  
 B6 - Wafer Style .....64  
 B6 - Lug Style .....64  
 B6 - Parts .....65  
 B7 - Wafer Style .....65  
 Butterfly Valve Part Breakdown .....60

## C Carbon Steel Ball Valves

Carbon Steel Valves Part Breakdown .....38  
 Flanged .....39  
 Mounting Pad .....39, 40, 42  
 Socket Weld .....42  
 Threaded .....40, 42  
 Three Piece .....42  
 Two Piece .....39, 40

## ITEM NAME PAGE NUMBER

### C (continued)

#### Cast Iron Check Valves

AWWA .....53  
 IBBM .....52  
 Lever & Weight .....53  
 Resilient Seat .....52, 53  
 UL/FM .....53  
 Wafer .....54  
 Cast Iron Flanges .....56

#### Cast Iron Gate Valves

AWWA .....46, 48, 51  
 Flanged .....46-51  
 Flanged X MJ .....46, 48  
 IBBM .....49-51  
 Mechanical Joint .....46  
 NRS .....46-50  
 OS&Y .....49-51  
 Resilient Wedge .....46-48, 51  
 Ring Tite .....47, 48  
 Rising Stem .....49-51  
 Threaded .....47, 49-50  
 UL/FM .....51  
 Cast Iron Globe Valve .....51

#### Check Valves

Brass .....17  
 Bronze .....17-18  
 Inline .....18-19  
 BUNA-N Seat .....17  
 Horizontal Pattern .....17  
 NSF .....17, 18  
 PVC .....19  
 Spring Loaded .....18  
 Stainless Steel .....43  
 Sump Pump .....19  
 Swing .....17-18  
 Y Pattern .....18  
 Circulator Flange Kit .....34  
 Coin Key Valves .....30  
 Companion Flanges .....56  
 Convector Valve .....29  
 CPVC Ball Valve .....11

### D

Drain Valve .....30  
 Ductile Iron Gate Valves .....48, 51

### E

Escutcheons & Keys .....9  
 Evaporator Cooler Valve .....33

### F

Flanges .....56  
 Flange Accessory Kits .....57  
 Flange Kits .....34  
 Float Rod .....33  
 Float Valve .....33  
 Foot Valve .....18  
 Frost Free Sillcock .....28

### G

Gaskets .....57

#### Gas Valves

1 Piece - CSA/UL .....8  
 2 Piece - CSA/UL .....8  
 Log Lighter - CSA .....9

#### Gate Valves

Angle .....29  
 Compression Ends .....14  
 Cross Handle .....12-13

## ITEM NAME PAGE NUMBER

### G (continued)

Crown Handle .....12  
 Curb Stop Handle .....13  
 Federal Specification .....13  
 Heavy Pattern .....12-13  
 IAPMO .....12  
 NRS .....12-14  
 NSF .....12  
 OS&Y .....13  
 Quick Opening .....14  
 Radiator .....29  
 Rising Stem .....13  
 Stainless Steel .....43  
 Wheel Handle .....12-14  
 With CPVC Stub Outs .....14

With Drain .....12  
 UL/FM .....13

#### Globe Valves

Hard Seat .....15  
 Long Bonnet .....15  
 Soft Seat .....15  
 Stainless Steel .....43  
 Stop & Waste .....20  
 Stops .....20

#### Garden Valve

Aztec .....22  
 Brass .....27

### H

Hose Bibb .....22, 24-26

### I

Inline Check Valve .....18-19

### L

Log Lighters - CSA .....9  
 Loose Key Valve .....24

### M

Meter Valve .....33  
 MJ Accessory Sets .....58

### N

**No Kink**  
 Valve .....24  
 Hose Bibb .....24-25

### O

Oil Barrel Faucet .....34  
 Oil Tank Valve .....34  
 Operating Nuts .....59

### P

Press Ball Valve .....5  
 Purge Valve .....34  
 PVC Flanges .....56

#### PVC Valves

Ball Valves .....10-11  
 Check Valves .....19

### Q

Quick Opening Gate Valve .....14

### R

**Radiator Valves**  
 Angle Valve .....29-30  
 Hot Water Radiator .....30  
 Radiator Gate Valve .....29  
 Steam Radiator .....29-30

## ITEM NAME PAGE NUMBER

### S

Silent Check Valve .....54

#### Sillcocks

Aztec .....23  
 Brass .....27  
 Frost Free .....28  
 With Pex Ends .....28  
 With Vacuum Breaker .....27  
 Slip Nuts .....29  
 Spring Loaded Check Valve .....18

#### Stainless Steel Ball Valves

Flanged .....39  
 Mounting Pad .....39-41  
 One Piece .....39  
 Socket Weld .....41  
 Stainless Steel Valves Part Breakdown .....38  
 Threaded .....39-41  
 Three Piece .....41  
 Two Piece .....39, 40  
 Stainless Steel Check Valve .....43  
 Stainless Steel Gate Valve .....43  
 Stainless Steel Globe Valve .....43  
 Stainless Steel Y Strainer .....43  
 Steam Valves .....29-30

#### Stop Valves

Brass .....20  
 Globe .....20  
 Sump Pump Check Valve .....19

#### Supply Valves

**Multi Turn**  
 Angle .....31  
 Compression .....31  
 Dual Compression .....31  
 Pex Compression .....31  
 Straight .....31

#### Quarter Turn- Oval Handles

Angle .....32  
 Compression .....32  
 Dual Compression .....32  
 Pex Compression .....32  
 Straight .....32  
 Swing Check Valve .....17-18

### T

T-Wrench .....58

### V

#### Vacuum Breakers

Aztec .....23-24  
 Brass .....22  
 Chrome .....22

### W

Wafer Check Valve .....54  
 Water Heater Drain Valve .....30  
 Wheel Handles .....59

### Y

**Y Strainers**  
 Bronze .....16  
 Cast Iron .....55  
 Stainless Steel .....43

# Certifications & Approvals

## Committed to Quality

**Matco-Norca** is committed to maintaining a high standard of quality for all the products we offer. Most products in this catalog are labeled with a designated approval or certification code. Below is a brief description of these approvals.



**ADA** **American Disabilities Act** — Protecting the rights of people with physical or mental disabilities.



**ANSI** **American National Standards Institute** — Organization that coordinates work among U.S. Standards writing groups; Works in conjunction with other groups such as ISO, ASME, ASTM, etc.



**ASME** **American Society of Mechanical Engineers** — Develops standards and testing criteria for finished products.



**ASSE** **American Society of Sanitary Engineering** — Develops standards and qualifies products for plumbing and sanitary installations.



**ASTM** **American Society for Testing Materials** — Develops standards for materials, products, systems and services.



**AWWA** **American Water Works Association** — Promotes public health through improvement of water quality. Develops standards for valves, fittings and equipment.



**CSA** **Canadian Standards Association** — Develops standards, tests and qualifies products used in gas lines and gas appliance installations.



**FM** **Factory Mutual** — Develops standards and qualifies products for use by the general public.



**ISO** **International Standards Association** — A worldwide process control organization. An internationally recognized certification for manufacturers that comply with high standards of quality control. Developed standards ISO-9000 through ISO-9004



**MSS** **Mechanics Standardization Society of the Valves & Fittings Industry, Inc.** — A committee of manufacturers that develops technical codes and standards for the valve & fitting industry.



**SDWA** **The Safe Drinking Water Act** — Is the main federal law that ensures the quality of Americans' drinking water. Under SDWA, EPA sets standards for drinking water quality and oversees the states, localities, and water suppliers who implement those standards. Weighted average lead content of water contact components must be 0.25% or less.



**NSF** **NSF International** — An organization committed to public health that writes standards and certifies products for food, water and consumer products.



**UL** **Underwriter's Laboratory** — Tests and qualifies valve and fittings products under UL standards for safety.



**UPC** **Uniform Plumbing Code** — Developed by the International Association of Plumbing and Mechanical Officials to govern the installation and inspection of plumbing systems as a means of promoting the public's health, safety and welfare.



**USC** **University of Southern California** — Foundation for Cross-Connection Control and Hydraulic Research that lists approved backflow prevention assemblies.

# Ball Valves - Full Port



757

## Ball Valve - Full Port - Forged Brass - UL/FM Certified 1/4" - 2"

Lead Free Version Available

CSA Approved - 1/4" - 2"

1/4" - 2" - 150 SWP 600 WOG 2-1/2" - 4" - 125 SWP 400 WOG

IPS

MATCO-NORCA MODEL NUMBER	SIZE	CARTON QUANTITIES INNER	CARTON QUANTITIES MASTER
757T01	1/4"	12	144
757T02	3/8"	12	144
757T03	1/2"	12	144
757T04	3/4"	10	70
757T05	1"	10	60
757T06	1-1/4"	6	36
757T07	1-1/2"	4	24
757T08	2"	4	6
757T09	2-1/2"	2	6
757T10	3"	2	4
757T11	4"	2	2

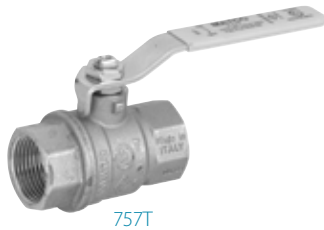

759

## Ball Valve - Full Port - Forged Brass

Lead Free Version Available

CSA Approved - 1/2" - 2" IPS Only

1/4" - 2" - 150 SWP 600 WOG 2-1/2" - 4" - 100 SWP 600 WOG

IPS

C x C

MATCO-NORCA MODEL NUMBER	SIZE	CARTON QUANTITIES INNER	CARTON QUANTITIES MASTER
759T01	-	15	120
759T02	-	15	120
759T03	759C03	15	120
759T04	759C04	10	60
759T05	759C05	8	48
759T06	759C06	4	24
759T07	759C07	2	24
759T08	759C08	2	12
759T09	759C09	2	6
759T10	759C10	1	4
759T11	759C11	1	2

Also Available with Tee Handle: 1/4" - 1"

759T01T	-	12	144
759T03T	759C03T	15	120
759T04T	759C04T	10	60
-	759C05T	8	48

Also Available with Stainless Steel Thumb Grip Handle: 1/2" - 1-1/4"

Handles Are Not Interchangeable.

759T03TS	759C03TS	15	120
759T04TS	759C04TS	10	80
759T05TS	759C05TS	8	48
759T06TS	-	4	24

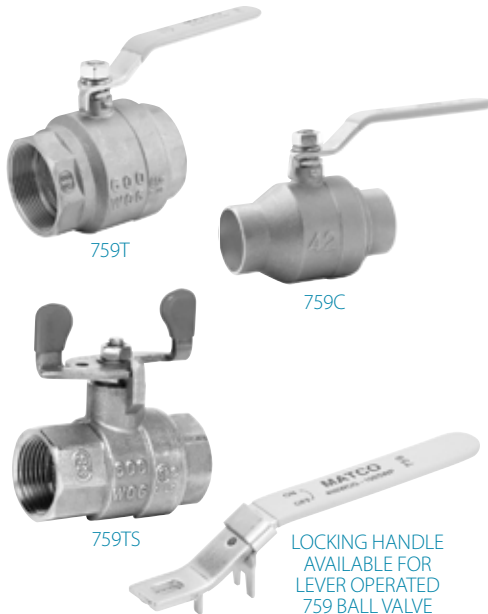

759MF

## Ball Valve - Full Port - Forged Brass - MIP X FIP

600 WOG

Lead Free Version Available

With Tee Handle

759MF0001T	1/8" X 1/4"	12	144
759MF00T	1/8" X 1/8"	12	144
759MF01T	1/4" X 1/4"	12	144



# Ball Valves - Full Port & Standard Port



## 759PLF

### Lead Free Press Ball Valve - Full Port - Forged Brass

#### 150 SWP 600 WOG

MATCO-NORCA MODEL NUMBER	SIZE	CARTON QUANTITIES INNER	CARTON QUANTITIES MASTER
759P03LF	1/2"	15	120
759P04LF	3/4"	10	60
759P05LF	1"	8	48
759P06LF	1-1/4"	4	24
759P07LF	1-1/2"	2	24
759P08LF	2"	2	12
759P09LF	2-1/2"	2	6
759P10LF	3"	2	4
759P11LF	4"	1	2

## 758

### Ball Valve - Full Port - Forged Brass - Made In Italy

#### 1/2" - 2" - 150 SWP 600 WOG

#### C x C

MATCO-NORCA MODEL NUMBER	SIZE	CARTON QUANTITIES INNER	CARTON QUANTITIES MASTER
758C03	1/2"	10	120
758C04	3/4"	5	60
758C05	1"	4	48
758C06	1-1/4"	4	32
758C07	1-1/2"	2	24
758C08	2"	2	16

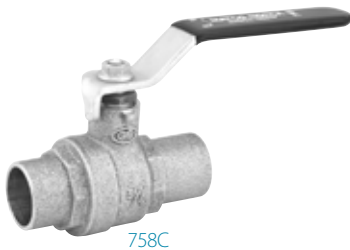

## 755

### Ball Valve - Full Port - Forged Brass - Heavy Duty - Made In Italy

#### 1/4" - 2" - 150 SWP 600 WOG

#### Nickel Plated

#### IPS

MATCO-NORCA MODEL NUMBER	SIZE	CARTON QUANTITIES INNER	CARTON QUANTITIES MASTER
755T01	1/4"	10	150
755T02	3/8"	10	120
755T03	1/2"	20	120
755T04	3/4"	12	60
755T05	1"	10	30
755T06	1-1/4"	4	20
755T07	1-1/2"	4	16
755T08	2"	2	6
755T09	2-1/2"	1	5
755T10	3"	1	5
755T11	4"	1	4

#### 2-1/2" - 4" - 100 SWP 400 WOG

#### UL/FM Certified 1/2" - 2"

## 760

### Ball Valve - Standard Port - One Piece - 316 Stainless Steel

#### 1/4" - 1-1/4" - 1000 WOG

#### IPS

MATCO-NORCA MODEL NUMBER	SIZE	CARTON QUANTITIES INNER	CARTON QUANTITIES MASTER
760T01	1/4"	60	250
760T02	3/8"	40	160
760T03	1/2"	20	80
760T04	3/4"	10	40
760T05	1"	10	40
760T06	1-1/4"	5	20
760T07	1-1/2"	4	16
760T08	2"	2	8



# Ball Valves - Full Port & Standard Port



## 754N

### Ball Valve - Full Port - Forged Brass

**1/4" - 2" - 150 SWP 600 WOG 2-1/2" - 4" - 100 SWP 400 WOG**  
**Nickel Plated**

IPS

MATCO-NORCA MODEL NUMBER	SIZE	CARTON QUANTITIES INNER	MASTER
754T01N	1/4"	30	120
754T02N	3/8"	30	120
754T03N	1/2"	15	120
754T04N	3/4"	10	90
754T05N	1"	6	60
754T06N	1-1/4"	6	36
754T07N	1-1/2"	4	24
754T08N	2"	2	16
754T09N	2-1/2"	1	8
754T10N	3"	1	6
754T11N	4"	1	4
<i>Also Available with Stainless Steel Cross Handle - IPS Only</i>			
754T05NX	1"	5	60

## 752N

### Ball Valve - Standard Port - Forged Brass

**Lead Free Version Available**

**150 SWP 400 WOG**

IPS

C x C



MATCO-NORCA MODEL NUMBER	SIZE	CARTON QUANTITIES INNER	MASTER
752T01N	1/4"	6	240
752T02N	3/8"	6	240
752T03N	1/2"	6	120
752T04N	3/4"	6	120
752T05N	1"	6	60
752T06N	1-1/4"	2	30
752T07N	1-1/2"	2	30
752T08N	2"	2	24
752T09N	2-1/2"	1	12
752T10N	3"	1	8
752T11N	4"	1	6
<i>Also Available with Stainless Steel Cross Handle - IPS Only</i>			
752T03NX	1/2"	10	100
752T04NX	3/4"	10	100

## 300BV

### Long Bonnet Brass Ball Valve - Full Port

**Lead Free Version Available**

**600 WOG**



MATCO-NORCA MODEL NUMBER	SIZE	CARTON QUANTITIES INNER	MASTER
300LC3BV	1/2" C x C	6	72
300LT3BV	1/2" IPS	6	72
300LC4BV	3/4" C x C	6	72
300LT4BV	3/4" IPS	6	72

# Ball Valves - Full Port & Standard Port



752CMP

## 752CMP

### Ball Valve - Standard Port - Forged Brass

Lead Free Version Available  
400 WOG

With Compression Ends For Copper Tube Pipe

MATCO-NORCA MODEL NUMBER	SIZE	CARTON QUANTITIES INNER	MASTER
752CMP3	1/2" nominal	25	100
752CMP4	3/4" nominal	15	60
752CMP5	1" nominal	10	40



752TUF



752CUF

## 752UF

### Ball Valve - Full Port - Uni-Flange With Gasket, 2 Bolts & 2 Nuts

400 WOG

IPS x Flange

Copper x Flange

MATCO-NORCA MODEL NUMBER	SIZE	CARTON QUANTITIES INNER	MASTER
752T04UF	3/4"	1	24
752T05UF	1"	2	18
752T06UF	1-1/4"	1	12
752T07UF	1-1/2"	1	10



754DT



754DC

## 754D

### Ball Valve - Full Port - Cast Brass - With Waste Drain

Lead Free Version Available  
400 WOG

IPS

C x C

MATCO-NORCA MODEL NUMBER	SIZE	CARTON QUANTITIES INNER	MASTER
754DT3	1/2"	20	80
754DT4	3/4"	10	40
754DT5	1"	4	16
754PCAP	1/2" - 1"	1	500

Drain Cap



754PX03LF



754PXDE04LF

## 754PXLF

### Lead Free Ball Valve - Full Port - Forged Brass - Pex Barb Ends

600 WOG

Max 50 PSI @ 200° F

MATCO-NORCA MODEL NUMBER	SIZE	CARTON QUANTITIES INNER	MASTER
754PX03LF	1/2" x 1/2" PEX	10	100
754PX04LF	3/4" x 3/4" PEX	10	100
754PX05LF	1" x 1" PEX	8	48
With Waste Drain & Drop Ear			
754PXDE03LF	1/2" x 1/2" PEX	8	80
754PXDE04LF	3/4" x 3/4" PEX	8	80
754PXDE05LF	1" x 1" PEX	4	40



755MF



755MFZ

## 755MF

### Ball Valve - Male X Female - Cast Bronze

Lead Free Version Available  
150 SWP 600 WOG Test Cock

With Lever Handle

MATCO-NORCA MODEL NUMBER	SIZE	CARTON QUANTITIES INNER	MASTER
755MF00	1/8" MIP x 1/8" FIP	12	144
755MF0	1/8" MIP x 1/4" FIP	12	144
755MF1	1/4" MIP x 1/4" FIP	12	144

With Slotted Screw

755MFZ0	1/8" MIP x 1/4" FIP	50	200
755MFZ1	1/4" MIP x 1/4" FIP	20	200

# Gas Valves

Image	SP	UL	MATCO-NORCA		CARTON QUANTITIES		
			MODEL NUMBER	SIZE	INNER	MASTER	
 <p>58LGN</p>	SP	UL	<b>58LGN</b>	<b>Gas Ball Valve - 1/2 PSIG And 5G - Two Piece</b>			
				FIP x FIP			
				58LGA3N	1/2"	12	120
				58LGA4N	3/4"	12	120
			58LGA5N	1"	10	60	

 <p>58LGF</p>	SP	UL	<b>58LGF</b>	<b>Gas Ball Valve - 1/2 PSIG And 5G - Two Piece</b>			
				FIP x Flare			
				58LGF32	1/2" FIP x 3/8" FL	12	144
				58LGF33	1/2" FIP x 1/2" FL	12	144
				58LGF39	1/2" FIP x 9/16" - 24	12	144
			58LGF4	3/4" FIP x 15/16" - 24	12	144	

 <p>58LGF</p>	SP	UL	<b>58LGF</b>	<b>Gas Ball Valve - 1/2 PSIG And 5G - Two Piece</b>		
				Flare x Flare		
				58LGF2	3/8" O.D. x 3/8" O.D.	12
			58LGF3	1/2" O.D. x 1/2" O.D.	12	144



 <p>59LGA</p>	SP	UL	<b>59LGA</b>	<b>Gas Ball Valve - 1/2 PSIG And 5G - Made In Italy - One Piece</b>			
				FIP x FIP			
				59LGA2	3/8"	1	100
				59LGA3	1/2"	12	96
			59LGA4	3/4"	20	80	



 <p>59LGF</p>	SP	UL	<b>59LGF</b>	<b>Gas Ball Valve - 1/2 PSIG And 5G - Made In Italy - One Piece</b>			
				FIP x Flare			
				59LGF32	1/2" FIP x 3/8" FL	1	144
				59LGF33	1/2" FIP x 1/2" FL	12	144
				59LGF34	3/4" FIP x 1/2" FL	1	1
			59LGF39	1/2" FIP x 9/16" - 24	12	144	

 <p>59LGF</p>	SP	UL	<b>59LGF</b>	<b>Gas Ball Valve - 1/2 PSIG And 5G - Made In Italy - One Piece</b>			
				Flare x Flare			
				59LGF2	3/8" O.D. x 3/8" O.D.	1	100
				59LGF3	1/2" O.D. x 1/2" O.D.	12	144
			59LGF4	5/8" O.D. x 5/8" O.D.	1	100	



# Log Lighter Valves & Accessories

SP	58ST	MATCO-NORCA MODEL NUMBER	SIZE	CARTON QUANTITIES	
				INNER	MASTER
<b>Log Lighter Valves</b>					
<b>Valve Only</b>					
	58-S03	58-S03	1/2" Straight Valve	15	120
	58-A03	58-A03	1/2" Angle Valve	15	120
<b>Straight Valve - Complete Kits Include Valve, Escutcheon And 3" Key</b>					
	58-STR03	58-STR03	1/2" With Chrome Plated Escutcheon & Key	1	25
	58-STR03P	58-STR03P	1/2" With Polished Brass Escutcheon & Key	1	25
<b>Angle Valve - Complete Kits Include Valve, Escutcheon And 3" Key</b>					
	58-ANG03	58-ANG03	1/2" With Chrome Plated Escutcheon & Key	1	25
	58-ANG03P	58-ANG03P	1/2" With Polished Brass Escutcheon & Key	1	25

SP	58	MATCO-NORCA MODEL NUMBER	SIZE	CARTON QUANTITIES	
				INNER	MASTER
<b>Log Lighter Valve - Escutcheons &amp; Keys</b>					
<b>Escutcheons</b>					
	58-300BN	58-300BN	Flat Brushed Nickel	1	1
	58-300PBD	58-300PBD	Domed Polished Brass	12	72
	58-300BND	58-300BND	Domed Brushed Nickel	1	1
	58-300SND	58-300SND	Domed Satin Nickel	20	72
	58-300CP	58-300CP	Flat Chrome Plated	20	120
	58-300PB	58-300PB	Flat Polished Brass	20	120
<b>Keys</b>					
	58-200CP	58-200CP	3" Chrome Plated for 1/4" Stem	1	400
	58-208CP	58-208CP	8" Chrome Plated for 1/4" Stem	1	400
	58-208PB	58-208PB	8" Polished Brass for 1/4" Stem	1	180
	58-212PB	58-212PB	12" Polished Brass for 1/4" Stem	20	120
	58-208BN	58-208BN	8" Brushed Nickel for 1/4" Stem	1	400
	58-212BN	58-212BN	12" Brushed Nickel for 1/4" Stem	20	100
	58-200SN	58-200SN	3" Satin Nickel for 1/4" Stem	1	1
	58-208SN	58-208SN	8" Satin Nickel for 1/4" Stem	50	400
	58-212SN	58-212SN	12" Satin Nickel for 1/4" Stem	20	100

Log Lighter Valves

# White PVC Ball Valves & Gray PVC Ball Valves



**770**

**Sch. 40 PVC Ball Valve - NSF - Solvent & Threaded - PTFE Seats**



770S



770T

**150 PSI @ 73° F**

**Fits Both Schedule 40 & 80 Pipe**

SOLVENT	THREADED	SIZE	CARTON QUANTITIES INNER	MASTER
770S03	770T03	1/2"	1	100
770S04	770T04	3/4"	1	100
770S05	770T05	1"	1	50
770S06	770T06	1-1/4"	1	50
770S07	770T07	1-1/2"	1	50
770S08	770T08	2"	1	20
770S09	770T09	2-1/2"	1	12
770S10	770T10	3"	1	12
770S11	770T11	4"	1	6

*See 770N Below for 6" PVC Ball Valve.*

**770N**

**Sch. 40 PVC Ball Valve - Solvent & Threaded - PTFE Seats**

**150 PSI @ 73° F**

**Fits Both Schedule 40 & 80 Pipe - Economy Pattern**



770SN



770TN

SOLVENT	THREADED	SIZE	CARTON QUANTITIES INNER	MASTER
770S03N	770T03N	1/2"	10	100
770S04N	770T04N	3/4"	10	100
770S05N	770T05N	1"	10	50
770S06N	770T06N	1-1/4"	5	50
770S07N	770T07N	1-1/2"	5	50
770S08N	770T08N	2"	5	20
770S09N	770T09N	2-1/2"	1	12
770S10N	770T10N	3"	1	12
770S11N	770T11N	4"	1	6
770S13N	-	6"	1	5

*Sizes 2-1/2" - 6" Come with Lever Handles.*



**770G**

**Sch. 80 PVC Ball Valve - NSF - Solvent & Threaded - PTFE Seats**

**150 PSI**

**Fits Both Schedule 40 & 80 Pipe**



770SG



770TG

SOLVENT	THREADED	SIZE	CARTON QUANTITIES INNER	MASTER
770S03G	770T03G	1/2"	1	100
770S04G	770T04G	3/4"	1	100
770S05G	770T05G	1"	1	50
770S06G	770T06G	1-1/4"	1	50
770S07G	770T07G	1-1/2"	1	50
770S08G	770T08G	2"	1	20
770S09G	770T09G	2-1/2"	1	12
770S10G	770T10G	3"	1	12
770S11G	770T11G	4"	1	6

# PVC & CPVC Ball Valves



773S

**773**

## PVC Ball Valve - Single Union - Solvent & Threaded - PTFE Seats

**150 PSI**

**SOLVENT**

773S07

773S08

**THREADED**

773T07

773T08

**SIZE**

1-1/2"

2"

**CARTON QUANTITIES**  
**INNER**      **MASTER**

1

1

48

24



772ST

**772ST**

## PVC Ball Valve - True Union - Solvent & Threaded Ends - PTFE Seats

**Both Solvent & Threaded Ends In Box**

772ST03

772ST04

772ST05

772ST06

772ST07

772ST08

1/2"

3/4"

1"

1-1/4"

1-1/2"

2"

1

1

1

1

1

1

72

60

45

24

16

12

*See Below for 3"- 4" True Union Ball Valves.*



IPS & SLIP ENDS



772S

**772**

## PVC Ball Valve - True Union - Solvent Or Threaded Ends - PTFE Seats

**Solvent or Threaded Ends In Box**

**150 PSI**

**SOLVENT**

772S10

772S11

**THREADED**

772T10

772T11

3"

4"

1

1

6

1



772T



**771**

## CPVC Ball Valve - NSF Approved - PTFE Seats

**100 PSI @ 180° F**

**SOLVENT**

771S03

771S04

771S05

771S06

771S07

771S08

1/2"

3/4"

1"

1-1/4"

1-1/2"

2"

1

1

5

1

1

1

100

100

40

100

48

24



771S

# Gate Valves



514

**MATCO-NORCA MODEL NUMBER** **SIZE** **CARTON QUANTITIES INNER MASTER**  
**Gate Valve - Full Port - Cast Brass - Solid Wedge**

**125 SWP 200 WOG**

**Lead Free Version Available**

**Only Available in Standard**

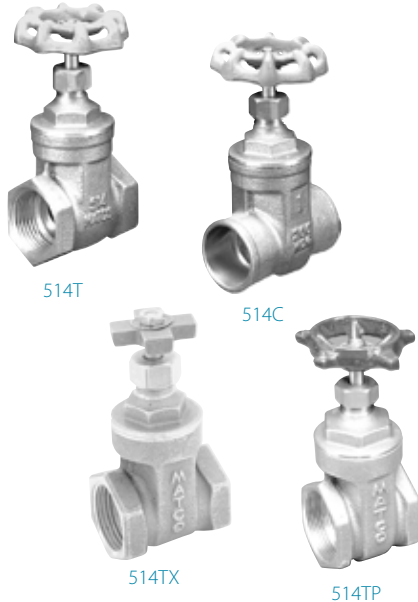

Wheel Handle IPS	Wheel Handle C x C	Cross Handle IPS	Crown Handle IPS	SIZE	CARTON QUANTITIES INNER	MASTER
514T01	-	-	-	1/4"	10	120
514T02	-	-	-	3/8"	10	120
514T03	514C03	514T03X	514T03P	1/2"	10	120
514T04	514C04	514T04X	514T04P	3/4"	10	80
514T05	514C05	514T05X	514T05P	1"	5	60
514T06	514C06	514T06X	514T06P	1-1/4"	5	40
514T07	514C07	514T07X	514T07P	1-1/2"	5	30
514T08	514C08	514T08X	514T08P	2"	2	24
514T09	514C09	514T09X	514T09P	2-1/2"	1	10
514T10	514C10	514T10X	514T10P	3"	1	6
514T11	514C11	514T11X	514T11P	4"	1	4

*Replacement Handles Of Each Type Are Available.*

503

**Gate Valve - Full Port - Bronze - Heavy Pattern**

**Lead Free Version Available**

**150 SWP 300 WOG**

**MSS-SP-80**

**IPS Only**



503T

Model Number	SIZE	CARTON QUANTITIES INNER	MASTER
503T03	1/2"	10	100
503T04	3/4"	6	60
503T05	1"	5	40
503T06	1-1/4"	5	30
503T07	1-1/2"	4	24
503T08	2"	4	16
503T09	2-1/2"	2	8
503T10	3"	1	6
503T11	4"	1	4

517

**Gate Valve With Drain - Cast Brass - Non Rising Stem**

**125 SWP 200 WOG**

**IPS**

**C x C**

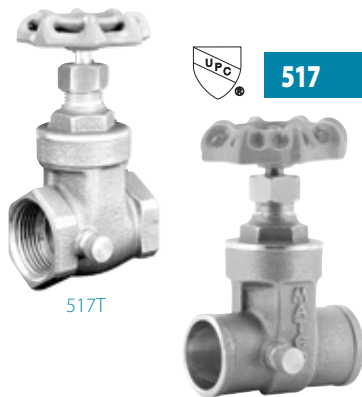

517T

517C

Model Number	Model Number	SIZE	CARTON QUANTITIES INNER	MASTER
517T03	517C03	1/2"	10	120
-	517C04	3/4"	10	90
517T05	517C05	1"	5	60

Brass & Bronze Gate Valves

# Bronze Gate Valves With Federal Specifications



501T

501	MATCO-NORCA MODEL NUMBER	SIZE	CARTON QUANTITIES	
			INNER	MASTER
<b>Gate Valve - OS&amp;Y - Rising Stem - Bronze B62</b>				
<b>175 CWP</b>				
IPS Only				
	501T04	3/4"	6	60
	501T05	1"	16	48
	501T06	1-1/4"	12	36
	501T07	1-1/2"	2	8
	501T08	2"	1	6

511	MATCO-NORCA MODEL NUMBER	SIZE	CARTON QUANTITIES		
			INNER	MASTER	
<b>Gate Valve - Federal Specification 54 Class A Type 1- Non Rising Stem - Bronze B62</b>					
<b>150 SWP 300 WOG</b>					
<b>MSS-SP-80</b>					
IPS C x C					
	511T03	511C03	1/2"	10	80
	511T04	511C04	3/4"	10	60
	511T05	511C05	1"	5	40
	511T06	511C06	1-1/4"	5	30
	511T07	511C07	1-1/2"	4	24
	511T08	511C08	2"	2	12



511T



511C

512	MATCO-NORCA MODEL NUMBER	SIZE	CARTON QUANTITIES		
			INNER	MASTER	
<b>Gate Valve - Federal Specification 54 Class A Type 1- Rising Stem - Bronze B62</b>					
<b>150 SWP 300 WOG</b>					
<b>MSS-SP-80</b>					
Lead Free Version Available Only Available in Standard					
IPS C x C					
	512T03	512C03	1/2"	1	80
	512T04	512C04	3/4"	1	60
	512T05	512C05	1"	1	40
	512T06	512C06	1-1/4"	1	30
	512T07	512C07	1-1/2"	1	24
	512T08	512C08	2"	1	12
	512T09	-	2-1/2"	1	8
	512T10	-	3"	1	4



512T



512C

513	MATCO-NORCA MODEL NUMBER	SIZE	CARTON QUANTITIES		
			INNER	MASTER	
<b>Gate Valve - Full Port - Heavy-Duty - Non Rising Stem - Bronze B62</b>					
<b>Lead Free Version Available</b>					
<b>125 SWP 200 WOG</b>					
<b>MSS-SP-80</b>					
IPS Only Wheel Handle Cross Handle Curb Stop Handle					
	513T04	-	3/4"	5	50
	513T05	-	1"	5	40
	513T06	-	1-1/4"	4	24
	513T07	-	1-1/2"	4	24
	513T08	513T08X	2"	1	6
	-	513T09X	2-1/2"	1	10
	-	513T10X	3"	1	6



513T



513TX



513CS

Replacement Handles Of Each Type Are Available.

# Gate Valves



519T

**ANSI**

**519**

## Gate Valve - Cast Brass - Non Rising Stem

**Lead Free Version Available**

**200 WOG**

**MSS-SP-92**

With Compression Ends For Copper Tube Pipe

MATCO-NORCA MODEL NUMBER	SIZE	CARTON QUANTITIES	
		INNER	MASTER
519T03	1/2" nominal	10	120
519T04	3/4" nominal	10	90
519T05	1" nominal	5	60



519TP

**ANSI**

**519TP**

## Gate Valve - Cast Brass - Compression With CPVC Stub-Outs

**Lead Free Version Available**

**200 WOG**

MATCO-NORCA MODEL NUMBER	SIZE	CARTON QUANTITIES	
		INNER	MASTER
519T03TP	1/2"	12	72
519T04TP	3/4"	10	90

**730**

## Quick Opening Gate Valve - Without Spring - Cast Bronze - Made In Italy

**125 SWP 200 WOG**

**IPS**

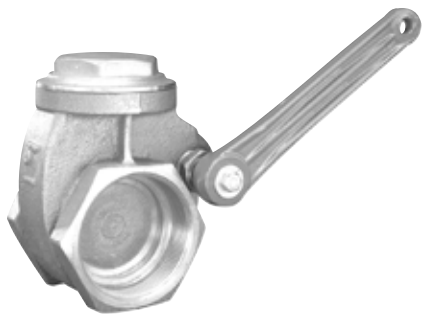

730T

MATCO-NORCA MODEL NUMBER	SIZE	CARTON QUANTITIES	
		INNER	MASTER
730T03	1/2"	20	100
730T04	3/4"	20	100
730T05	1"	10	50
730T06	1-1/4"	10	50
730T07	1-1/2"	6	30
730T08	2"	4	20
730T09	2-1/2"	2	12
730T10	3"	2	10
730T11	4"	1	5

# Globe Valves



200TLF

**200LF**

**Lead Free Globe Valve - Brass - Hard Seat**

MATCO-NORCA MODEL NUMBER	SIZE	CARTON QUANTITIES	
		INNER	MASTER
<b>125 PSI</b>			
IPS			
200T02LF	3/8"	10	100
200T03LF	1/2"	10	100
200T04LF	3/4"	5	60
200T05LF	1"	5	40
200T06LF	1-1/4"	5	30
200T07LF	1-1/2"	4	24
200T08LF	2"	2	16

**240T**

**Angle Control Valve - Globe Pattern - Brass - Soft Seat - Cross Handle**

**Lead Free Version Available**

**125 PSI**

IPS



240T

240T04	3/4"	8	40
240T05	1"	4	24
240T06	1-1/4"	2	10
240T07	1-1/2"	2	10
240T08	2"	2	10

**240H**

**Angle Control Valve - Globe Pattern - Brass - Soft Seat - Bronze Wheel Handle**

**Lead Free Version Available**

**125 PSI**

IPS



240TH

240T08H	2"	2	24
---------	----	---	----

**200L/200AL**

**Globe Valve - Long Bonnet - Brass - Soft Seat**

**Lead Free Version Available**

**125 PSI**

**Straight Pattern**



200LT



200ALC

200LT3	1/2" IPS	12	72
200LT4	3/4" IPS	12	72
200LC3	1/2" C x C	12	72
200LC4	3/4" C x C	12	72
<b>Angle Pattern</b>			
200ALT3	1/2" IPS	12	72
200ALC3	1/2" C x C	12	72

# Bronze Y Strainers

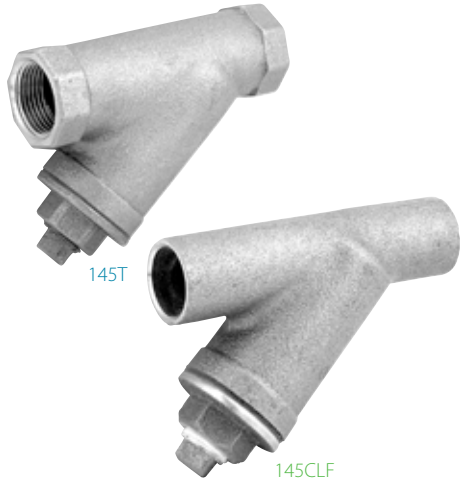

Bronze Y Strainers

145	MATCO-NORCA MODEL NUMBER			SIZE	CARTON QUANTITIES	
	Y Strainer - Cast Bronze - With Brass Plug - 18 Mesh Stainless Steel Screen		INNER		MASTER	
	<b>150 SWP</b>	<b>300 WOG</b>				
	<b>Lead Free Version Available</b>	<b>Lead Free Only</b>				
	<b>IPS</b>	<b>C x C</b>	<b>Size</b>	<b>Tap &amp; Plug Size</b>		
	145T01	-	1/4"	1/8"	12	48
	145T02	-	3/8"	1/8"	12	48
	145T03	145C03LF	1/2"	1/4"	12	48
	145T04	145C04LF	3/4"	1/4"	8	48
	145T05	145C05LF	1"	3/8"	8	32
	145T06	145C06LF	1-1/4"	3/8"	8	24
	145T07	145C07LF	1-1/2"	1/2"	2	16
	145T08	145C08LF	2"	1/2"	2	8
	145T09	-	2-1/2"	1-1/4"	1	6
	145T10	-	3"	1-1/2"	1	4

Replacement Screens Available.



# Swing Check Valves - Brass & Bronze

ANSI	521	MATCO-NORCA MODEL NUMBER	SIZE	CARTON QUANTITIES	
				INNER	MASTER
<b>Swing Check Valve - Cast Brass - Brass Seat</b>					
<b>200 WOG</b>					
<b>Lead Free Version Available</b>					
<b>IPS</b>					
 <p>521T</p> <p>521CLF</p>	521T02	-	3/8"	12	120
	521T03	521C03LF	1/2"	12	120
	521T04	521C04LF	3/4"	10	80
	521T05	521C05LF	1"	5	60
	521T06	521C06LF	1-1/4"	5	40
	521T07	521C07LF	1-1/2"	5	30
	521T08	521C08LF	2"	2	24
	<b>Lead Free Only</b>				
<b>C x C</b>					
<b>Lead Free Version Available</b>					
521T09	521C09	2-1/2"	1	15	
521T10	521C10	3"	1	6	
521T11	521C11	4"	1	6	

ANSI	521N	MATCO-NORCA MODEL NUMBER	SIZE	CARTON QUANTITIES	
				INNER	MASTER
<b>Swing Check Valve - Cast Brass - BUNA-N Seat</b>					
<b>Lead Free Version Available</b>					
<b>200 WOG</b>					
<b>IPS</b>					
 <p>521N</p>	521N02	-	3/8"	1	120
	521N03	-	1/2"	10	120
	521N04	-	3/4"	10	80
	521N05	-	1"	5	60
	521N06	-	1-1/4"	1	40
	521N07	-	1-1/2"	5	20
	521N08	-	2"	1	24
	521N09	-	2-1/2"	1	15
	521N10	-	3"	1	6
	521N11	-	4"	1	6

ANSI	530	MATCO-NORCA MODEL NUMBER	SIZE	CARTON QUANTITIES	
				INNER	MASTER
<b>Swing Check Valve - Cast Bronze B62 - Bronze Disc - Horizontal Pattern</b>					
<b>Lead Free Version Available</b>					
<b>150 SWP 300 WOG</b>					
<b>IPS</b>					
 <p>530T</p>	530T02	-	3/8"	12	120
	530T03	-	1/2"	12	120
	530T04	-	3/4"	10	80
	530T05	-	1"	5	60
	530T06	-	1-1/4"	5	40
	530T07	-	1-1/2"	5	30
	530T08	-	2"	2	24
	530T09	-	2-1/2"	1	15
	530T10	-	3"	1	6
	530T11	-	4"	1	6

Brass & Bronze  
Check Valves

# Check Valves Foot Valve



532T

532	MATCO-NORCA MODEL NUMBER	SIZE	CARTON QUANTITIES	
			INNER	MASTER
<b>Swing Check Valve Y Pattern - Bronze B62</b>				
<b>150 SWP 300 WOG</b>				
IPS				
	532T03	1/2"	10	90
	532T04	3/4"	10	80
	532T05	1"	10	60
	532T06	1-1/4"	5	30
	532T07	1-1/2"	4	24
	532T08	2"	2	16

## 525 Inline Check Valve - Spring Loaded - Bronze B62 - 1/2 PSI Crack Pressure



525T

**Lead Free  
Version  
Available**

**Lead Free  
Only**

200 WOG				
IPS		CXC		
	525T03	1/2"	10	100
	525T04	3/4"	10	80
	525T05	1"	6	60
	525T06	1-1/4"	4	40
	525T07	1-1/2"	5	30
	525T08	2"	5	20
	525C03LF	1/2"	10	100
	525C04LF	3/4"	10	80
	525C05LF	1"	6	60
	525C06LF	1-1/4"	4	40
	525C07LF	1-1/2"	5	30
	525C08LF	2"	5	20

## 527LF Lead Free Foot Valve - Stainless Steel Screen - Bronze B62



527LF

200 WOG				
IPS				
	527T03LF	1/2"	1	100
	527T04LF	3/4"	1	80
	527T05LF	1"	1	60
	527T06LF	1-1/4"	1	40
	527T07LF	1-1/2"	1	30
	527T08LF	2"	1	20

# PVC Check Valve

## Sump Pump Check Valve



523S



523T

**523**

### PVC Inline Check Valve - 304 SS Spring - 1/2 PSI Crack Pressure - One Piece

**Max 150 PSI @ 122° F**

**SOLVENT**

**THREADED**

MATCO-NORCA MODEL NUMBER	SIZE	CARTON QUANTITIES INNER	CARTON QUANTITIES MASTER
523S03	1/2"	1	120
523S04	3/4"	1	120
523S05	1"	1	80
523S06	1-1/4"	1	60
523S07	1-1/2"	1	60
523S08	2"	1	40

**529**

### Sump Pump Check Valve - Flexible Rubber Connections - Stainless Steel Clamps



529

MATCO-NORCA MODEL NUMBER	SIZE	CARTON QUANTITIES INNER	CARTON QUANTITIES MASTER
529-0808	2" x 2"	10	50
529-0706	1-1/2" x 1-1/4"	10	50

# Stop Valves - Globe Style

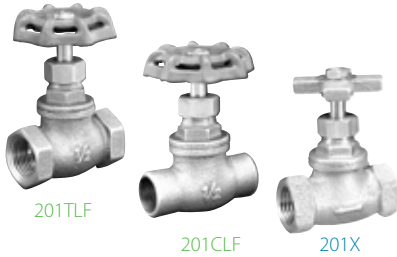

## 201

### Stop Valve - Globe Style - Brass - Soft Seat

**125 PSI**

**Lead Free Only**

**Lead Free Version Available**

IPS

C x C

IPS With Cross Handle

201T03LF

201C03LF

201X03

1/2"

12

72

201T04LF

201C04LF

201X04

3/4"

12

72

Replacement Handles Available.



## 202LF

### Stop & Waste Valve - Globe Style - Brass - Soft Seat

**125 PSI**

IPS

C x C

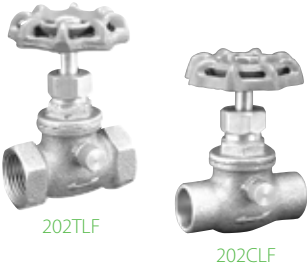

202T03LF

202C03LF

1/2"

12

72

202T04LF

202C04LF

3/4"

12

72



## 201A

### Angle Stop Valve - Globe Style - Brass - Soft Seat

**Lead Free Version Available**

**125 PSI**

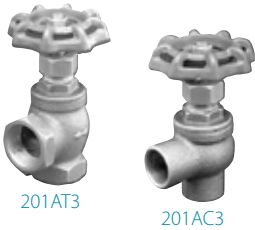

201AT3

1/2" IPS

12

72

201AC3

1/2" C x C

12

72



## 201/202CMLF

### Lead Free Stop & Waste Valve - Brass Nut & Ferrule

**125 PSI**

With Compression Ends For Copper Tube Pipe

With Waste Cap



201CMLF

202CMLF

1/2" nominal

12

72

201CM4LF

202CM4LF

3/4" nominal

12

72

# Brass Boiler Drains - Full Flow

**205F** **Boiler Drain - 3/4" Hose Outlet - Angle Spout - With Stuffing Box**



**Lead Free Version Available**

**125 PSI**

MATCO-NORCA MODEL NUMBER	SIZE	CARTON QUANTITIES INNER	CARTON QUANTITIES MASTER
<b>MIP</b>			
205F03*	1/2"	12	72
205F04	3/4"	12	72
* 1/2" MIP & 1/2" SWT Inlet			
<b>FIP</b>			
205FF3	1/2"	12	72
205FF4	3/4"	12	72

**205** **Boiler Drain - 3/4" Hose Outlet - With Stuffing Box**



**Lead Free Version Available**

**125 PSI**

MATCO-NORCA MODEL NUMBER	SIZE	CARTON QUANTITIES INNER	CARTON QUANTITIES MASTER
<b>MIP</b>			
205TM3*	1/2"	12	72
205TM4	3/4"	12	72
* 1/2" MIP & 1/2" SWT Inlet			
<b>FIP</b>			
205TF3	1/2"	12	72
205TF4	3/4"	12	72
<b>CTS Compression With Nut &amp; Ferrule</b>			
205TR3	1/2"	12	72

**205CM** **Boiler Drain - 3/4" Hose Outlet - Angle Spout - With Stuffing Box**



**125 PSI**

MATCO-NORCA MODEL NUMBER	SIZE	CARTON QUANTITIES INNER	CARTON QUANTITIES MASTER
<b>Inlet</b>			
205CM3	1/2" Male Copper Sweat	12	72

**204** **Boiler Drain - 3/4" Hose Outlet - Less Stuffing Box**















**Lead Free Version Available**

**125 PSI**

MATCO-NORCA MODEL NUMBER	SIZE	CARTON QUANTITIES INNER	CARTON QUANTITIES MASTER
<b>MIP</b>			
204TM3*	1/2"	12	72
204TM4	3/4"	12	72
204LS3*	Long Shank 1/2" MIP With Locknut	12	72
204LS3P*	Long Shank 1/2" NPT x Chamfer For Cone Connection With Locknut	12	72
* 1/2" MIP & 1/2" SWT Inlet			











# Vacuum Breaker & Back Flow Preventers

## Aztec Low Pressure Valves

		MATCO-NORCA MODEL NUMBER	SIZE	CARTON QUANTITIES INNER MASTER		
 <p>646AS4 646ASC</p>		<b>646AS</b>	<b>Hose Bibb Vacuum Breaker - Brass - With Break-Away Set Screw</b>			
		<p><b>Lead Free Version Available</b>  <b>Conforms To ASSE 1011</b>  <b>Hose Connection</b></p>				
		646AS4	3/4" Brass Finish	12	144	
		646ASC	3/4" Chrome Plated	12	144	
 <p>BFP-90LF</p>		<b>BFP-90LF</b>	<b>Lead Free Back Flow Preventer - Brass - With Atmospheric Vent</b>			
		<p><b>Conforms to ASSE 1012</b>  <b>Max 175 PSI @ 250° F</b>                      IPS                      C x C</p>				
		BFP-90-1/2LF	BFP-90-1/2-CLF	1/2" FIP	1	24
		BFP-90-3/4LF	-	3/4" FIP	1	24
 <p>DCV-04LF</p>		<b>DCVLF</b>	<b>Lead Free Dual Check Back Flow Preventer - Brass</b>			
		<p><b>Conforms to ASSE 1024</b>  <b>Max 175 PSI @ 140° F</b>                      IPS</p>				
		DCV-04LF		3/4"	1	24
		DCV-05LF	1"	1	24	
 <p>AZ646R</p>		<b>AZ646R</b>	<b>Aztec Hose Bibb With Tee Handle - Graphite Packing</b>			
		<p><b>Lead Free Version Available</b>  <b>125 PSI</b></p>				
		AZ646R03		Inlet 1/2" MIP	12	72
		AZ646R04	3/4" MIP	12	72	
 <p>AZ203TF</p>		<b>AZ203</b>	<b>Aztec Bent Nose Garden Valve With Stuffing Box - Graphite Packing</b>			
		<p><b>Lead Free Version Available</b>  <b>125 PSI</b></p>				
		AZ203TF3		Inlet 1/2" FIP	12	72
		AZ203TF4	3/4" FIP	12	72	
		AZ203TF5	1" FIP	12	72	
 <p>AZ205C034 AZ205TF AZ205TM</p>		<b>AZ205</b>	<b>Aztec Boiler Drain With Stuffing Box - Graphite Packing</b>			
		<p><b>Lead Free Version Available</b>  <b>125 PSI</b></p>				
		AZ205C034		3/4" Copper Fitting & 1/2" Copper Sweat	12	72
		AZ205TF3	1/2" FIP	12	72	
		AZ205TF4	3/4" FIP	12	72	
		AZ205TM3	1/2" MIP	12	72	
		AZ205TM4	3/4" MIP	12	72	

Aztec Low Pressure Valves

# Aztec Low Pressure Valves Sillcocks

	MATCO-NORCA MODEL NUMBER	SIZE	CARTON QUANTITIES		
			INNER	MASTER	
  AZ206C034   AZ206T	<b>AZ206 Aztec Sillcock With Stuffing Box - Brass - Graphite Packing</b>				
	 <b>Lead Free Version Available</b> <b>125 PSI</b>				
			Inlet		
	AZ206C034		3/4" Copper Fitting & 1/2" Copper Sweat	12	72
	AZ206T03 AZ206T04		1/2" FIP 3/4" FIP	12 12	72 72
  AZ206T/VB	<b>AZ206/VB Aztec Sillcock With Vacuum Breaker - Brass - Graphite Packing</b>				
	 <b>Lead Free Version Available</b> <b>125 PSI</b>				
	AZ206T03/VB AZ206T04/VB		1/2" FIP 3/4" FIP	12 12	72 72
  AZ206LK	<b>AZ206/LK Aztec Sillcock With Vacuum Breaker - Loose Key - Graphite Packing</b>				
	 <b>Lead Free Version Available</b> <b>125 PSI</b>				
	AZ206T03LK AZ206T04LK		1/2" FIP 3/4" FIP	12 12	72 72

Aztec Low Pressure Valves

# Aztec Low Pressure Valves



**AZ207**

**MATCO-NORCA MODEL NUMBER**      **SIZE**      **CARTON QUANTITIES INNER MASTER**

**Aztec No Kink Hose Bibb - Brass - Graphite Packing**

**Lead Free Version Available**  
**125 PSI**



AZ207C04

AZ207TF

AZ207C04

**Inlet**

3/4" Copper Fitting and  
1/2" Copper Sweat

12

72

AZ207TF3

1/2" FIP

12

72

AZ207TF4

3/4" FIP

12

72



AZ207TM

AZ207TR

AZ207TM3

1/2" MIP

12

72

AZ207TM4

3/4" MIP

12

72

AZ207TR3

1/2" CTS Compression  
With Nut & Ferrule

12

72



**AZ207**

**Aztec Loose Key Valve - No Kink - Brass - Graphite Packing**

**Lead Free Version Available**  
**125 PSI**



AZ207TFLK

AZ207TMLK

AZ207TF3LK

**Inlet**

1/2" FIP

12

72

AZ207TF4LK

3/4" FIP

12

72

AZ207TM3LK

1/2" MIP

12

72

AZ207TM4LK

3/4" MIP

12

72



**AZ207**

**Aztec No Kink Valve With Vacuum Breaker - Brass - Graphite Packing**

**Lead Free Version Available**  
**125 PSI**



AZ207TF/VB

AZ207TM/VB

AZ207TF3/VB

**Inlet**

1/2" FIP

12

72

AZ207TF4/VB

3/4" FIP

12

72

AZ207TM3/VB

1/2" MIP

12

72

AZ207TM4/VB

3/4" MIP

12

72



# Hose Bibbs

## Ball Valve Hose Bibbs



**646R**

**MATCO-NORCA  
MODEL NUMBER**

**646R Hose Bibb - Male - Cast Brass**

**SIZE**

**CARTON QUANTITIES  
INNER MASTER**

**Lead Free Version Available**

**125 PSI**

**Inlet**

646R03	1/2" MIP & 1/2" SWT x 3/4" Hose	12	72
646R04	3/4" MIP x 3/4" Hose	12	72
646R05	1" MIP x 1" Hose	12	48
P646R03H	Replacement Handle for 1/2" & 3/4"	1	100



**646BV**

**646BV Ball Valve Hose Bibb - Forged Brass - 1/4 Turn - 3/4" Hose Outlet**

**Lead Free Version Available**

**125 PSI**

**Inlet**

646BV03	1/2" MIP & 1/2" SWT	12	24
646BV04	3/4" MIP	12	24
P646BVC43H	Replacement Handles	1	1000



207TM



207TF



207C

**207**

**No Kink Hose Bibb - 3/4" Hose Outlet**

**Lead Free Version Available**

**125 PSI**

**MIP**

**Inlet**

207TM3	1/2"	12	72
207TM4	3/4"	12	72

**FIP**

207TF3	1/2"	12	72
207TF4	3/4"	12	72

**Sweat**

207C04	1/2" Sweat & 3/4" Copper Fitting	12	72
--------	----------------------------------	----	----





# Plumbing Specialty Brass Hose Bibbs

		MATCO-NORCA MODEL NUMBER	SIZE	CARTON QUANTITIES	
				INNER	MASTER
<b>FY</b>		<b>Hose Bibb - Brass - Tee Handles</b>			
		<b>Lead Free Version Available</b>			
		<b>125 PSI</b>			
	FY-675	FY-675	Chrome Plated Hose Bibb Plain End Outlet 1/2" FIP Inlet - Flanged	12	72
	FY-680	FY-680	Chrome Plated Hose Bibb 3/4" Hose End Outlet 1/2" FIP Inlet - Flanged	12	72
	FY-681	FY-681	Chrome Plated Hose Bibb Plain End Outlet 1/2" MIP Inlet - Adj. Flange	12	72
	FY-682	FY-682	Chrome Plated Hose Bibb 3/4" Hose End Outlet 1/2" MIP Inlet - Adj. Flange	12	72
	FY-685	FY-685*	Chrome Plated Hose Bibb 3/4" Hose End Outlet 1/2" FIP Inlet	12	72
	FY-690	FY-690	Chrome Plated Hose Bibb 3/4" Hose End Outlet 1/2" MIP Inlet	12	72
	FY-691	FY-691	Chrome Plated Hose Bibb Plain End Outlet 1/2" MIP Inlet	12	72
	FY-691PB*	FY-691PB*	Polished Brass Hose Bibb (not shown) Plain End Outlet 1/2" MIP Inlet	12	72
	FY-692	FY-692	Rough Brass Hose Bibb Plain End Outlet 1/2" MIP Inlet	12	72
	FY-695	FY-695	Chrome Plated Hose Bibb 3/4" Hose End Outlet 3/4" MIP Inlet	12	144

**\* Only Available in Standard**

# Brass Sillcocks Garden Valves

Sillcocks

	MATCO-NORCA MODEL NUMBER		SIZE	CARTON QUANTITIES		
				INNER	MASTER	
 <p>206T      206C</p> 	<b>206</b>		<b>Sillcock - 3/4" Hose Outlet - Brass Body</b>			
	<p><b>Lead Free Version Available</b></p> <p><b>125 PSI</b></p>					
		FIP	Sweat	Inlet		
		206T03	206C03	1/2"	12	72
		206T04	206C04	3/4"	12	72
 <p>206T03H</p>  <p>206VB</p>  <p>206HLK</p>	<b>206H</b>		<b>Sillcock - Heavy Pattern - 3/4" Hose Outlet - Brass Body - With Stuffing Box</b>			
	<p><b>Lead Free Version Available</b></p> <p><b>125 PSI</b></p>					
		FIP		Inlet		
		206T03H		1/2" FIP	12	72
	206T04H		3/4" FIP	12	72	
<b>206VB</b>		<b>Sillcock - With ASSE 1011 Vacuum Breaker</b>				
<p><b>Lead Free Version Available</b></p> <p><b>125 PSI</b></p>						
	FIP		Inlet			
	206T03VB		1/2" FIP	12	72	
<b>206HLK</b>		<b>Sillcock - Loose Key - Heavy Pattern - Female - 3/4" Hose Outlet</b>				
<p><b>125 PSI</b></p>						
	FIP		Inlet			
	206T03HLK		1/2" FIP	12	72	
	206T04HLK		3/4" FIP	12	72	
<b>203</b>		<b>Garden Valve - Bent Nose - Female - 3/4" Hose Outlet</b>				
<p><b>Lead Free Version Available</b></p> <p><b>125 PSI</b></p>						
	Bent Nose		Inlet			
	203TF3		1/2" FIP	12	72	
	203TF4		3/4" FIP	12	72	
	203TF5		1" FIP	12	72	
	Inverted Nose					
	203IF4		3/4" FIP	12	72	
	Loose Key					
	203TL3		1/2"	12	72	
	203TL4		3/4"	12	72	
	203TL5		1"	12	72	
	Key Only					
	203TLK			1	200	

# Frost Free Sillcocks



**209**

## Frost Free Sillcock - 3/4" Hose Outlet

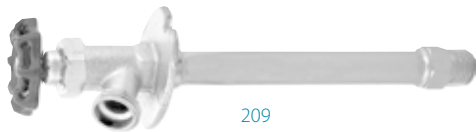

209

**MATCO-NORCA  
MODEL NUMBER**

**SIZE**

**CARTON QUANTITIES  
INNER MASTER**

**125 PSI**  
**Lead Free Version Available**  
 1/2" MIP & 1/2" SWT Inlet

**Only Available in Standard**

209004  
209006  
209008  
209010  
209012

**Length**

4"  
6"  
8"

1 24  
1 24  
1 24

209014

10"  
12"  
14"

1 24  
1 24  
1 24

**With Loose Key**

209008LK

8"

1 24

209010LK

10"

1 24

209012LK

12"

1 24

3/4" MIP & 1/2" FIP Inlet

**Length**

209404  
209406  
209408

4"  
6"  
8"

1 24  
1 24  
1 24

209410  
209412  
209414

10"  
12"  
14"

1 24  
1 24  
1 24



**209PX**

## Frost Free Sillcock - Pex - 3/4" Hose Outlet

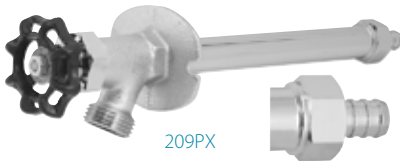

209PX

**125 PSI**  
 1/2" PEX Inlet

209004PX  
209006PX  
209008PX  
209010PX  
209012PX

4"  
6"  
8"  
10"  
12"

1 24  
1 24  
1 24  
1 24  
1 24



**212**

## Frost Free Sillcock - Anti Syphon - 3/4" Hose Outlet



212

**Lead Free Version Available**

**125 PSI**  
 1/2" MIP & 1/2" SWT Inlet

212004  
212006  
212008  
212010  
212012  
212014  
212KIT

**Length**

4"  
6"  
8"  
10"  
12"  
14"

1 24  
1 24  
1 24  
1 24  
1 24  
1 24

*212KIT - Vacuum Breaker Kit Available.*



**212PX**

## Frost Free Sillcock - Pex - Anti Syphon - 3/4" Hose Outlet

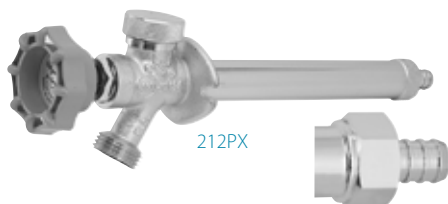

212PX

**Lead Free Version Available**

**125 PSI**  
 1/2" PEX Inlet

212004PX  
212006PX  
212008PX  
212010PX  
212012PX  
212014PX

4"  
6"  
8"  
10"  
12"  
14"

1 24  
1 24  
1 24  
1 24  
1 24  
1 24

# Steam Radiator Angle & Gate Valves Slip Nuts, Convector Valve



BARVY

MATCO-NORCA MODEL NUMBER	SIZE	CARTON QUANTITIES	
		INNER	MASTER
<b>BARVY Steam Radiator Angle Valve - Brass - Heavy Pattern</b>			
BARVY-0500	1/2" FIP With Nut & Tailpiece	10	60
BARVY-0750	3/4" FIP With Nut & Tailpiece	6	48
BARVY-1000	1" FIP With Nut & Tailpiece	4	36
BARVY-1250	1-1/4" FIP With Nut & Tailpiece	2	24
BARVY-1500	1-1/2" FIP With Nut & Tailpiece	2	16



BARV

MATCO-NORCA MODEL NUMBER	SIZE	CARTON QUANTITIES	
		INNER	MASTER
<b>BARV Steam Radiator Angle Valve - Bronze - Heavy Pattern</b>			
BARV-0500	1/2" FIP With Nut & Tailpiece	10	60
BARV-0750	3/4" FIP With Nut & Tailpiece	6	48
BARV-1000	1" FIP With Nut & Tailpiece	4	36
BARV-1250	1-1/4" FIP With Nut & Tailpiece	2	24
BARV-1500	1-1/2" FIP With Nut & Tailpiece	2	18
BARV-2000	2" FIP With Nut & Tailpiece	1	8



NT

MATCO-NORCA MODEL NUMBER	SIZE	CARTON QUANTITIES	
		INNER	MASTER
<b>NT Slip Nuts - Chrome</b>			
NT-100	1" Nut & Tail Piece For BARVY-1000 & BARV-1000	10	100
NT-125	1-1/4" Nut & Tail Piece For BARVY-1250 & BARV-1250	10	100



SGV

MATCO-NORCA MODEL NUMBER	SIZE	CARTON QUANTITIES	
		INNER	MASTER
<b>SGV Steam Radiator Gate Valve - Brass</b>			
SGV-1251	1-1/4" FIP With Nut & Tailpiece	4	24



BSGV

MATCO-NORCA MODEL NUMBER	SIZE	CARTON QUANTITIES	
		INNER	MASTER
<b>BSGV Steam Radiator Gate Valve - Bronze - Heavy Pattern</b>			
BSGV-0750	3/4" FIP With Nut & Tailpiece	6	48
BSGV-1000	1" FIP With Nut & Tailpiece	4	36
BSGV-1250	1-1/4" FIP With Nut & Tailpiece	4	24
BSGV-1500	1-1/2" FIP With Nut & Tailpiece	4	24



BCV

MATCO-NORCA MODEL NUMBER	SIZE	CARTON QUANTITIES	
		INNER	MASTER
<b>BCV Convector Valve - Bronze</b>			
BCV-1250	1-1/4" FIP With FIP Union	2	20

# Radiator Valve & Air Valves Drain Valve



AHV

## AHV

### Angle Hot Water Radiator Valve - Brass

MATCO-NORCA MODEL NUMBER	SIZE	CARTON QUANTITIES	
		INNER	MASTER
AHV-0500	1/2" FIP With Nut & Tailpiece	1	60
AHV-0750	3/4" FIP With Nut & Tailpiece	1	60
AHV-1000	1" FIP With Nut & Tailpiece	4	36
AHV-1250	1-1/4" FIP With Nut & Tailpiece	2	24
AHV-0500C	1/2" SWT With Nut & Tailpiece	1	60
AHV-0750C	3/4" SWT With Nut & Tailpiece	1	60



CK-100



KEY-100



HAV-125

## CK/KEY

### Coin Key Air Valve

CK-100	Coin Key Air Valve Nickle Plated	1/8"	100	1000
CKU-102	Key Air Valve	1/8"	100	1000
KEY-100	Key For Air Valve	1/8"	100	2000
HAV-125	Auto Vent HW & Steam	1/8"	50	500



AVA-125



AVS-125



ADJ-180

## AVA/AVS/ADJ

### Chrome Plated Steam Air Valves

AVA-125	1/8" Angle - MIP		12	144
AVS-125	1/8" Straight - MIP		1	144
AVS-250	1/4" Straight - MIP		1	144
AVS-750	3/4" MIP & 1/2" FIP Straight		1	144
ADJ-180	1/8" Angle MIP Adjustable		12	144



205WH4





















## 205WH

### Water Heater Drain Valve - Brass - Heavy Pattern

 **Lead Free Version Available**

205WH4	3/4" x 2-1/4" Long 3/4" MIP & 1/2" FIP Inlet		12	72
--------	---	--	----	----

# Multi-Turn Supply Valves

		MATCO-NORCA MODEL NUMBER	SIZE	CARTON QUANTITIES INNER MASTER		
  29-1001LF  29-1003PXL  29-1009LF  29-1019LF  29-1019CPVCLF  29-2001PXL	<b>29LF</b>	<b>Lead Free Supply Valves - Oval Handle With Compression Outlet - Angle</b>				
		<b>125 PSI</b>				
		29-1001LF	CP 3/8" FIP x 3/8" OD Compression	10	200	
		29-1003LF	CP 1/2" FIP x 3/8" OD Compression	10	200	
		29-1003PXL	CP 1/2" PEX x 3/8" OD Compression	10	200	
		29-1003BLF	Unplated 1/2" FIP x 3/8" OD Compression	10	200	
		29-1009LF	CP 1/2" SWT x 3/8" OD Compression	10	200	
		29-1009BLF	Unplated 1/2" SWT x 3/8" OD Compression	10	200	
		29-1019LF	CP 5/8" OD Compression x 3/8" OD Compression	10	200	
		29-1019BLF	Unplated 5/8" OD Compression x 3/8" OD Compression	10	200	
		29-1019CPVCLF	CP 5/8" OD CPVC x 3/8" OD	10	200	
		29-2001PXL	CP 1/2" PEX x 3/8" OD Compression x 3/8" OD Compression	10	200	
  29-1004LF  29-1004PXL  29-1010LF  29-1014LF  29-1010BLF  29-1014CPVCLF	<b>29LF</b>	<b>Lead Free Supply Valves - Oval Handle With Compression Outlet - Straight</b>				
		<b>125 PSI</b>				
		29-1002LF	CP 3/8" FIP x 3/8" OD Compression	10	200	
		29-1004LF	CP 1/2" FIP x 3/8" OD Compression	10	200	
		29-1004PXL	CP 1/2" PEX x 3/8" OD Compression	10	200	
		29-1010LF	CP 1/2" SWT x 3/8" OD Compression	10	200	
		29-1010BLF	Unplated 1/2" SWT x 3/8" OD Compression	10	200	
		29-1014LF	CP 5/8" OD Compression x 3/8" OD Compression	10	200	
		29-1014CPVCLF	CP 5/8" OD CPVC x 3/8" OD Straight Stop	10	200	
		29-1020LF	CP 1/2" OD Compression x 3/8" OD Compression	10	200	
	29-1575LF	CP 5/8" OD Compression x 5/8" OD Compression	10	200		
  29-1040LF  29-1041LF	<b>29LF</b>	<b>Lead Free Supply Valves - Oval Handle With Compression Outlet With 5" Extension and Bell Escutcheon</b>				
		<b>125 PSI</b>				
	29-1040LF	CP 1/2" SWT x 3/8" OD Compression - Angle	10	100		
	29-1041LF	CP 1/2" SWT x 3/8" OD Compression - Straight	10	100		
  29-2001LF  29-2001BLF	<b>29LF</b>	<b>Lead Free Supply Valves Oval - Handle With Dual Compression Outlet - Angle</b>				
		<b>125 PSI</b>				
	29-2001LF	CP 5/8" OD x 3/8" OD x 3/8" OD	10	200		
	29-2001BLF	Unplated 5/8" OD x 3/8" OD x 3/8" OD	10	200		

Multi-Turn Supply Valves

# Quarter Turn Supply Valves

		MATCO-NORCA MODEL NUMBER	SIZE	CARTON QUANTITIES INNER MASTER		
		<b>26LF</b>	<b>Lead Free Supply Valves - Oval Handle - With Compression Outlet - Angle</b>			
			<b>125 PSI</b>			
		26-1001LF	CP 3/8" FIP x 3/8" OD Compression	10	200	
		26-1003LF	CP 1/2" FIP x 3/8" OD Compression	10	200	
		26-1003PXL	CP 1/2" PEX x 3/8" OD Compression	10	200	
		26-1009LF	CP 1/2" Sweat x 3/8" OD Compression	10	200	
		26-1009BLF	Unplated 1/2" Sweat x 3/8" OD Compression	10	200	
		26-1019LF	CP 5/8" OD Compression x 3/8" OD Compression	10	200	
		26-1019BLF	Unplated 5/8" OD Compression x 3/8" OD Compression	10	200	
		26-1019CPVCLF	CP 5/8" OD CPVC Compression x 3/8" OD Compression	10	200	
		<b>26LF</b>	<b>Lead Free Supply Valves - PEX - Oval Handle - With Compression Outlet - Straight</b>			
			<b>125 PSI</b>			
		26-1002LF	CP 3/8" FIP x 3/8" OD Compression	10	200	
		26-1004LF	CP 1/2" FIP x 3/8" OD Compression	10	200	
		26-1004PXL	CP 1/2" PEX x 3/8" OD Compression	10	200	
		26-1010LF	CP 1/2" Sweat x 3/8" OD Compression	10	200	
		26-1010BLF	Unplated 1/2" Sweat x 3/8" OD Compression	10	200	
		26-1014LF	CP 5/8" OD Compression x 3/8" OD Compression	10	200	
26-1014PVCLF	CP 5/8" OD CPVC Compression x 3/8" OD Compression	10	200			
		<b>26LF</b>	<b>Lead Free Supply Valves - Oval Handle - With Compression Outlet</b>			
			<b>125 PSI</b>	<b>With 5" Extension and Bell Escutcheon</b>		
		26-1041LF	CP 1/2" Sweat x 3/8" OD Compression - Angle	10	100	
26-1040LF	CP 1/2" Sweat x 3/8" OD Compression - Straight	10	100			
		<b>26LF</b>	<b>Lead Free Supply Valves - Oval Handle - With Dual Compression Outlet - Angle</b>			
			<b>125 PSI</b>			
26-2001LF	CP 5/8" OD Compression x 3/8" OD Compression	10	200			
26-2001BLF	Unplated 5/8" OD Compression x 3/8" OD Compression	10	200			
		<b>25LF</b>	<b>Lead Free Supply Valves - Lever Handle - With Compression Outlet - Straight</b>			
25-2000LF	CP Retro-Fit 3/8" OD Captured Nut x 3/8" OD Compression	10	200			



# Miscellaneous: Float Valve, Float Rod, Evaporator Cooler Float Valve, Meter Valve

Miscellaneous



FV-404

FV	MATCO-NORCA MODEL NUMBER		SIZE	CARTON QUANTITIES	
	INNER	MASTER			
<b>Float Valve - Bronze</b>					
Straight Thread Male Inlet - Plain Outlet					
Rod Size					
	FV-303P	1/2"	1/4" x 20"	12	72
	FV-404P	3/4"	1/4" x 20"	6	36
Straight Thread Male Inlet - Straight Thread Male Outlet					
	FV-303	1/2"	1/4" x 20"	1	72
	FV-404	3/4"	1/4" x 20"	6	48
Female Inlet - Plain Outlet					
	FV-505	1"	5/16" x 18"	4	36
	FV-606	1-1/4"	3/8" x 16"	2	20
	FV-707	1-1/2"	3/8" x 16"	2	16
	FV-808	2"	3/8" x 16"	2	12



FR12-1

FR	MATCO-NORCA MODEL NUMBER		Length	Thread Pattern	CARTON QUANTITIES	
	INNER	MASTER				
<b>Float Rod - Brass</b>						
	FR12-1		12"	1/4" - 20	5	500
	FR12-15		12"	5/16" - 18	5	250
	FR12-2		12"	3/8" - 16	1	200

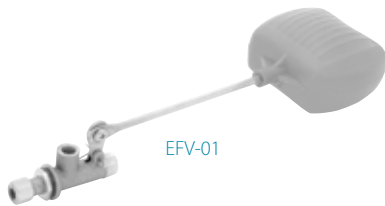

EFV-01

EFV	MATCO-NORCA MODEL NUMBER		SIZE	CARTON QUANTITIES	
	INNER	MASTER			
<b>Evaporator Cooler Float Valve</b>					
	EFV-01		1/4" Compression Inlet x 1/4" FIP Outlet	20	80



434-0404LF



434-0404DLF

434LF	MATCO-NORCA MODEL NUMBER		SIZE	CARTON QUANTITIES	
	INNER	MASTER			
<b>Lead Free Meter Valve - Brass</b>					
Angle Valve - Flare x IPS					
	434-0403LF		3/4" FL x 1/2" IPS	6	36
	434-0404LF		3/4" FL x 3/4" IPS	6	36
	434-0504LF		1" FL x 3/4" IPS	6	24
	434-0505LF		1" FL x 1" IPS	4	24
Angle Valve With Drain - Flare x IPS					
	434-0404D		3/4" FL x 3/4" IPS	6	36
	434-0505D		1" FL x 1" IPS	4	24

# Miscellaneous: Oil Tank Valve, Oil Barrel Faucet, Balancing Valves, Circulator Flange Kits

	MATCO-NORCA MODEL NUMBER	SIZE	CARTON QUANTITIES	
			INNER	MASTER
 <p>OTV-100</p> <p>OTV-200</p>	<b>OTV Oil Tank Valve - Brass - Hard Seat</b>			
	OTV-100	1/2" MIP X 3/8" MIP	6	72
	OTV-200	1/2" MIP X 3/8" FL	1	72
 <p>59DB04</p>	<b>59 Oil Barrel Faucet - Locking Lever</b>			
	59DB04	3/4" MIP x Plain Spout - Zamac	10	100
 <p>759SDS</p>	<b>759SDS Ball Style Balancing Valve</b>			
	<p> <b>Lead Free Version Available</b></p> <p>600 WOG</p>			
	759C04SDS	3/4" C x C With Screwdriver Stop	10	60
 <p>PBVC04C</p>	<b>PBVC Brass Purge &amp; Balancing Valve</b>			
	PBV04C	3/4" SWT x 1/2" FIP With Drain Outlet	12	60
 <p>CIF04</p>	<b>CIF Circulator Flange Kits - Cast Iron - With Bolts &amp; Nuts</b>			
	Complete with 2 Flanges, 4 Bolts, 4 Nuts			
	CIF04	3/4"	1	30
	CIF05	1"	1	30
	CIF06	1-1/4"	1	30

# Notes

# Carbon Steel Valves

Carbon Steel Valves



# Stainless Steel Valves



Stainless Steel Valves

Valves

# Carbon & Stainless Steel Valve Part # Breakdown

20SSFL08D

**20 SS FL 08 D**

Choose Series	
15	One Piece, Reduced Port
20	Two Piece, Full Port
25	Two Piece, Reduced Port
30	Three Piece, Full Port
40	Gate Valve
50	Globe Valve
60	Check Valve
70	Y Strainer

Choose Material	
CS	Carbon Steel
SS	Stainless Steel

Select Style	
D	Direct Mounting Pad
FL	Flange
M	Mounting Pad
SW	Socket Weld
TH	Threaded

Part #	Size
01	1/4"
02	3/8"
03	1/2"
04	3/4"
05	1"
06	1-1/4"
07	1-1/2"
08	2"
09	2-1/2"
10	3"
11	4"
13	6"
14	8"
15	10"



# Carbon & Stainless Steel Ball Valves

Carbon & Stainless  
Steel Ball Valves



15SSTH

## 15SSTH

**MATCO-NORCA MODEL NUMBER**      **SIZE**      **WEIGHT**

**Stainless Steel Threaded Ball Valve - One Piece - Reduced Port**

**1000 WOG**

**Locking Handle**

MATCO-NORCA MODEL NUMBER	SIZE	WEIGHT
15SSTH01	1/4"	0.1
15SSTH02	3/8"	0.2
15SSTH03	1/2"	0.4
15SSTH04	3/4"	0.6
15SSTH05	1"	0.8
15SSTH06	1-1/4"	1.3
15SSTH07	1-1/2"	1.8
15SSTH08	2"	2.9

## 20SSFLD

**Stainless Steel Flanged Ball Valve - Two Piece - Full Port**

**Class 150**

**API 607 Fire Safe Approved - Up to 6"**

**Locking & Anti-Static Device**

**ISO 5211 Direct Mount**



20SSFLD

MATCO-NORCA MODEL NUMBER	SIZE	WEIGHT
20SSFL03D	1/2"	3.7
20SSFL04D	3/4"	4.6
20SSFL05D	1"	7.1
20SSFL06D	1-1/4"	8.2
20SSFL07D	1-1/2"	13.2
20SSFL08D	2"	17.6
20SSFL09D	2-1/2"	32.0
20SSFL10D	3"	40.2
20SSFL11D	4"	63.9
20SSFL13D	6"	114.6
20SSFL14D	8"	194.0
20SSFL15D	10"	315.3

## 20CSFLD

**Carbon Steel Flanged Ball Valve - Two Piece - Full Port**

**Class 150**

**API 607 Fire Safe Approved - Up to 6"**

**Locking & Anti-Static Device**

**ISO 5211 Direct Mount**



20CSFLD

MATCO-NORCA MODEL NUMBER	SIZE	WEIGHT
20CSFL03D	1/2"	3.7
20CSFL04D	3/4"	4.6
20CSFL05D	1"	7.1
20CSFL06D	1-1/4"	8.2
20CSFL07D	1-1/2"	13.2
20CSFL08D	2"	17.6
20CSFL09D	2-1/2"	32.0
20CSFL10D	3"	40.2
20CSFL11D	4"	63.9
20CSFL13D	6"	114.6
20CSFL15D	10"	315.3

# Carbon & Stainless Steel Ball Valves



20SSTHM

## 20SSTHM

### Stainless Steel Threaded Ball Valve - Two Piece - Full Port

**1000 WOG  
Locking Handle  
Mounting Pad**

MATCO-NORCA MODEL NUMBER	SIZE	WEIGHT
20SSTH01M	1/4"	0.5
20SSTH02M	3/8"	0.5
20SSTH03M	1/2"	0.7
20SSTH04M	3/4"	1.0
20SSTH05M	1"	1.7
20SSTH06M	1-1/4"	2.5
20SSTH07M	1-1/2"	3.9
20SSTH08M	2"	5.9
20SSTH09M	2-1/2"	12.4
20SSTH10M	3"	16.5

## 25SSTHM

### Stainless Steel Threaded Ball Valve - Two Piece - Reduced Port

**1/4" - 1" 2000 WOG    1-1/4" - 2" 1500 WOG  
Locking Handle  
Mounting Pad**



25SSTHM

25SSTH01M	1/4"	0.7
25SSTH02M	3/8"	0.7
25SSTH03M	1/2"	0.7
25SSTH04M	3/4"	1.4
25SSTH05M	1"	1.8
25SSTH06M	1-1/4"	3.2
25SSTH07M	1-1/2"	4.1
25SSTH08M	2"	6.0

## 25CSTHM

### Carbon Steel Threaded Ball Valve - Two Piece - Reduced Port

**1/4" - 1" 2000 WOG    1-1/4" - 2" 1500 WOG  
Locking Handle  
Mounting Pad**



25CSTHM

25CSTH01M	1/4"	0.7
25CSTH02M	3/8"	0.7
25CSTH03M	1/2"	0.7
25CSTH04M	3/4"	1.4
25CSTH05M	1"	1.8
25CSTH06M	1-1/4"	3.2
25CSTH07M	1-1/2"	4.1
25CSTH08M	2"	6.0



# Stainless Steel Ball Valves

Stainless Steel  
Ball Valves



30SSTH

MATCO-NORCA MODEL NUMBER	SIZE	WEIGHT
<b>30SSTH Stainless Steel Threaded Ball Valve - Three Piece - Full Port</b>		
<b>1000 WOG Locking Handle</b>		
30SSTH01	1/4"	0.8
30SSTH02	3/8"	0.8
30SSTH03	1/2"	1.1
30SSTH04	3/4"	1.5
30SSTH05	1"	2.2
30SSTH06	1-1/4"	3.5
30SSTH07	1-1/2"	5.5
30SSTH08	2"	7.7
30SSTH09	2-1/2"	14.8
30SSTH10	3"	20.9
30SSTH11	4"	42.1



30SSSW

<b>30SSSW Stainless Steel Socket Weld Ball Valve - Three Piece - Full Port</b>		
<b>1000 WOG Locking Handle</b>		
30SSSW01	1/4"	0.8
30SSSW02	3/8"	0.8
30SSSW03	1/2"	1.1
30SSSW04	3/4"	1.5
30SSSW05	1"	2.2
30SSSW06	1-1/4"	3.5
30SSSW07	1-1/2"	5.5
30SSSW08	2"	7.7
30SSSW09	2-1/2"	14.8
30SSSW10	3"	20.9
30SSSW11	4"	42.1



30SSTHM

<b>30SSTHM Stainless Steel Threaded Ball Valve - Three Piece - Full Port</b>		
<b>1000 WOG Locking Handle ISO 5211 Mounting Pad</b>		
30SSTH01M	1/4"	0.8
30SSTH02M	3/8"	0.8
30SSTH03M	1/2"	1.1
30SSTH04M	3/4"	1.5
30SSTH05M	1"	2.3
30SSTH06M	1-1/4"	3.6
30SSTH07M	1-1/2"	5.3
30SSTH08M	2"	7.7
30SSTH09M	2-1/2"	14.8
30SSTH10M	3"	21.6
30SSTH11M	4"	42.3



30SSWMM

<b>30SSWMM Stainless Steel Socket Weld Ball Valve - Three Piece - Full Port</b>		
<b>1000 WOG Locking Handle ISO 5211 Mounting Pad</b>		
30SSW01M	1/4"	0.8
30SSW02M	3/8"	0.8
30SSW03M	1/2"	1.1
30SSW04M	3/4"	1.5
30SSW05M	1"	2.3
30SSW06M	1-1/4"	3.6
30SSW07M	1-1/2"	5.3
30SSW08M	2"	7.7
30SSW09M	2-1/2"	14.8
30SSW10M	3"	21.6
30SSW11M	4"	42.3

# Carbon Steel Ball Valves



30CSTH

**30CSTH**

**Carbon Steel Threaded Ball Valve - Three Piece - Full Port**

**1000 WOG**

**Locking Handle**

MATCO-NORCA MODEL NUMBER	SIZE	WEIGHT
30CSTH01	1/4"	0.8
30CSTH02	3/8"	0.8
30CSTH03	1/2"	1.1
30CSTH04	3/4"	1.5
30CSTH05	1"	2.2
30CSTH06	1-1/4"	3.5
30CSTH07	1-1/2"	5.5
30CSTH08	2"	7.7
30CSTH09	2-1/2"	14.8
30CSTH10	3"	20.9
30CSTH11	4"	42.1

**30CSSW**

**Carbon Steel Socket Weld Ball Valve - Three Piece - Full Port**

**1000 WOG**

**Locking Handle**



30CSSW

30CSSW01	1/4"	0.8
30CSSW02	3/8"	0.8
30CSSW03	1/2"	1.1
30CSSW04	3/4"	1.5
30CSSW05	1"	2.2
30CSSW06	1-1/4"	3.5
30CSSW07	1-1/2"	5.5
30CSSW08	2"	7.7
30CSSW09	2-1/2"	14.8
30CSSW10	3"	20.9
30CSSW11	4"	42.1

**30CSTHM**

**Carbon Steel Threaded Ball Valve - Three Piece - Full Port**

**1000 WOG**

**Locking Handle**

**ISO 5211 Mounting Pad**



30CSTHM

30CSTH01M	1/4"	0.8
30CSTH02M	3/8"	0.8
30CSTH03M	1/2"	1.1
30CSTH04M	3/4"	1.5
30CSTH05M	1"	2.3
30CSTH06M	1-1/4"	3.6
30CSTH07M	1-1/2"	5.3
30CSTH08M	2"	7.7
30CSTH09M	2-1/2"	14.8
30CSTH10M	3"	21.6
30CSTH11M	4"	42.3

**30CSSWM**

**Carbon Steel Socket Weld Ball Valve - Three Piece - Full Port**

**1000 WOG**

**Locking Handle**

**ISO 5211 Mounting Pad**



30CSSWM

30CSSW01M	1/4"	0.8
30CSSW02M	3/8"	0.8
30CSSW03M	1/2"	1.1
30CSSW04M	3/4"	1.5
30CSSW05M	1"	2.3
30CSSW06M	1-1/4"	3.6
30CSSW07M	1-1/2"	5.3
30CSSW08M	2"	7.7
30CSSW09M	2-1/2"	14.8
30CSSW10M	3"	21.6
30CSSW11M	4"	42.3

# Stainless Steel Valves

Stainless Steel  
Valves



40SSTH

## 40SSTH

### Stainless Steel Threaded Gate Valve - NRS

#### 200 WOG

MATCO-NORCA MODEL NUMBER	SIZE	WEIGHT
40SSTH03	1/2"	1.0
40SSTH04	3/4"	1.2
40SSTH05	1"	1.5
40SSTH06	1-1/4"	2.2
40SSTH07	1-1/2"	3.1
40SSTH08	2"	5.0

## 50SSTH

### Stainless Steel Threaded Globe Valve - Rising Stem

#### 200 WOG

50SSTH03	1/2"	0.7
50SSTH04	3/4"	1.0
50SSTH05	1"	1.5
50SSTH06	1-1/4"	2.2
50SSTH07	1-1/2"	2.8
50SSTH08	2"	4.0



50SSTH

## 60SSTH

### Stainless Steel Threaded Check Valve

#### 200 WOG

60SSTH03	1/2"	0.7
60SSTH04	3/4"	1.0
60SSTH05	1"	1.5
60SSTH06	1-1/4"	2.2
60SSTH07	1-1/2"	3.4
60SSTH08	2"	4.7



60SSTH

## 70SSTH

### Stainless Steel Threaded Y Strainer - 40 Mesh Screen

#### 800 WOG

70SSTH03	1/2"	0.5
70SSTH04	3/4"	0.8
70SSTH05	1"	1.5
70SSTH06	1-1/4"	1.9
70SSTH07	1-1/2"	3.0
70SSTH08	2"	5.2



70SSTH

# Cast & Ductile Iron Valves

Cast Iron & Ductile Iron Valves Butterfly Valves & Accessories





# Cast Iron Gate Valves Resilient Wedge - Non-Rising Stem



200WW

## 200WW

### Flanged Cast Iron Gate Valve - Resilient Wedge - NRS

**AWWA C509 200 CWP**

**Fusion Bonded Epoxy**

**HANDWHEEL OP. NUT**

MATCO-NORCA MODEL NUMBER	SIZE	WEIGHT
200W08W	200W08NW 2"	31
200W10W	200W10NW 3"	53
200W11W	200W11NW 4"	77
200W13W	200W13NW 6"	135
200W14W	200W14NW 8"	209
200W15W	200W15NW 10"	333
200W16W	200W16NW 12"	462
<b>14" and 16" Sizes Of This Product Are Available As:</b>		
100W17	14"	750
100W18	16"	1026



200MW

## 200MW

### Mechanical Joint Cast Iron Gate Valve - Resilient Wedge - NRS

**AWWA C509 200 CWP**

**Fusion Bonded Epoxy**

**OP. NUT OPEN RIGHT**

MATCO-NORCA MODEL NUMBER	SIZE	WEIGHT
200M10W	- 3"	53
200M11W	200M11RW 4"	77
200M13W	200M13RW 6"	135
200M14W	200M14RW 8"	209
200M15W	200M15RW 10"	333
200M16W	200M16RW 12"	462
<b>14" and 16" Sizes Of This Product Are Available As:</b>		
100M17	14"	739
100M18	16"	942



200FJW

## 200FJW

### Flanged X MJ Cast Iron Gate Valve - Resilient Wedge - NRS - For IPS Pipe

**AWWA C509 200 CWP**

**Fusion Bonded Epoxy**

**OP. NUT**

MATCO-NORCA MODEL NUMBER	SIZE	WEIGHT
200FJ10W	3"	53
200FJ11W	4"	77
200FJ13W	6"	135
200FJ14W	8"	209
200FJ15W	10"	333
200FJ16W	12"	462

# Cast Iron Gate Valves Resilient Wedge - Non-Rising Stem



10RW



10RS-N



10RT

MATCO-NORCA MODEL NUMBER	SIZE	WEIGHT
<b>10RW Flanged Cast Iron Gate Valve - Resilient Wedge - NRS</b>		
<b>200 CWP 2" - 8" 150 CWP 10" - 12"</b>		
<b>3 Bosses - 1 Tapped &amp; Plugged USC Approved</b>		
<b>Epoxy Coated</b>		
<b>HANDWHEEL</b>	<b>OP. NUT</b>	
10RW08	10RW08N	2"
10RW09	-	2-1/2"
10RW10	10RW10N	3"
10RW11	10RW11N	4"
10RW12	10RW12N	5"
10RW13	10RW13N	6"
10RW14	10RW14N	8"
10RW15	-	10"
10RW16	-	12"
		25
		31
		42
		64
		97
		108
		191
		286
		393
<b>10RS Threaded Cast Iron Gate Valve - Resilient Wedge - NRS</b>		
<b>200 CWP</b>		
<b>Epoxy Coated</b>		
<b>HANDWHEEL</b>	<b>OP. NUT</b>	
10RS08	10RS08N	2"
10RS09	10RS09N	2-1/2"
10RS10	10RS10N	3"
10RS11	10RS11N	4"
10RS12	-	5"
10RS13	-	6"
		18
		20
		26
		44
		77
		95
<b>10RT Ring-Tite Cast Iron Gate Valve - Resilient Wedge - NRS - For IPS Pipe</b>		
<b>200 CWP</b>		
<b>3 Bosses - 1 Tapped &amp; Plugged</b>		
<b>Epoxy Coated</b>		
<b>OP. NUT</b>		
10RT08		2"
10RT09		2-1/2"
10RT10		3"
10RT11		4"
10RT13		6"
10RT14		8"
		20
		22
		33
		46
		90
		154

Cast Iron Gate Valves

# Ductile Iron Gate Valves Resilient Wedge - Non-Rising Stem

Ductile Iron Gate Valves

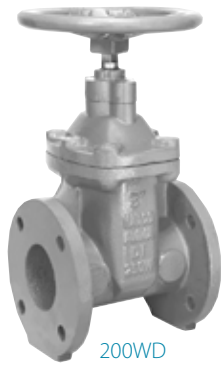

200WD

## 200WD

### Flanged Ductile Iron Gate Valve - Resilient Wedge - NRS

**AWWA C515 250 CWP**

**Fusion Bonded Epoxy**

**HANDWHEEL OP. NUT**

MATCO-NORCA MODEL NUMBER	SIZE	WEIGHT
200WD08	2"	28
200WD09	2-1/2"	37
200WD10	3"	45
200WD11	4"	69
200WD13	6"	119
200WD14	8"	203
200WD15	10"	282
200WD16	12"	412
200WD18	16"	1,602

*See 100W For 14" and 16" Sizes in Cast Iron On Page 40.*

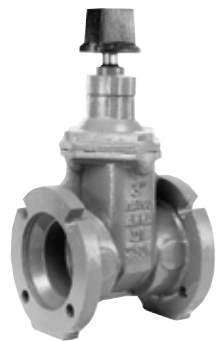

200MD

## 200MD

### Mechanical Joint Ductile Iron Gate Valve - Resilient Wedge - NRS - Less Accessories

**AWWA C515 250 CWP**

**Fusion Bonded Epoxy**

**OP. NUT**

MATCO-NORCA MODEL NUMBER	SIZE	WEIGHT
200MD08	2"	28
200MD10	3"	44
200MD11	4"	56
200MD13	6"	98
200MD14	8"	160
200MD15	10"	245
200MD16	12"	311

*See 100M For 14" and 16" Sizes in Cast Iron On Page 40.*

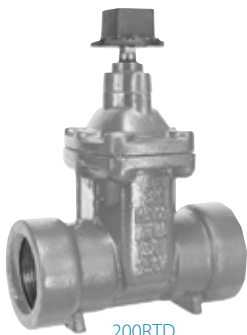

200RTD

## 200RTD

### Ring-Tite Ductile Iron Gate Valve - Resilient Wedge - NRS - For IPS Pipe

**AWWA C515 250 CWP**

**Fusion Bonded Epoxy**

**OP. NUT**

MATCO-NORCA MODEL NUMBER	SIZE	WEIGHT
200RTD08	2"	25
200RTD09	2-1/2"	31
200RTD10	3"	38
200RTD11	4"	54
200RTD13	6"	104
200RTD14	8"	171
200RTD15	10"	289
200RTD16	12"	447



200TVD

## 200TVD

### Ductile Iron Tapping Gate Valve - Resilient Wedge - NRS - Less Accessories

**AWWA C515 250 CWP**

**Fusion Bonded Epoxy**

**OP. NUT**

MATCO-NORCA MODEL NUMBER	SIZE	WEIGHT
200TVD10	3"	48
200TVD11	4"	63
200TVD13	6"	108
200TVD14	8"	173
200TVD15	10"	262
200TVD16	12"	374



# Cast Iron Gate Valves IBBM - Iron Body Bronze Mounted

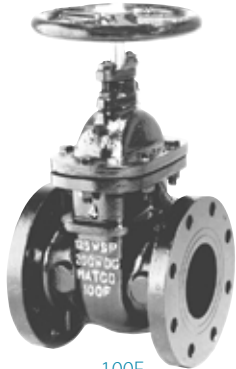

100F

MATCO-NORCA MODEL NUMBER	SIZE	WEIGHT
<b>100F</b>	<b>Flanged Cast Iron Gate Valve - IBBM - NRS</b>	
<b>125 SWP 200 WOG</b>		
<b>3 Bosses MSS SP-70 WW-V-58-CL1</b>		
<b>Bituminous Coated</b>		
<b>HANDWHEEL</b>		
100F08	2"	26
100F09	2-1/2"	35
100F10	3"	44
100F11	4"	77
100F12	5"	97
100F13	6"	128
100F14	8"	220
100F15	10"	315
100F16	12"	483
100F17	14"	807
100F18	16"	1077
100F19	18"	1301

*OP. Nuts Available. See Page 53 for Part Numbers.*



105F

MATCO-NORCA MODEL NUMBER	SIZE	WEIGHT
<b>105F</b>	<b>Flanged Cast Iron Gate Valve - OS&amp;Y - IBBM - Rising Stem</b>	
<b>125 SWP 200 WOG</b>		
<b>3 Bosses MSS SP-70 WW-V-58-CL1</b>		
<b>Bituminous Coated</b>		
105F08	2"	29
105F09	2-1/2"	37
105F10	3"	50
105F11	4"	86
105F12	5"	115
105F13	6"	150
105F14	8"	249
105F15	10"	374
105F16	12"	524
105F17	14"	816
105F18	16"	1187
105F19	18"	1413
105F20	20"	2104
105F24	24"	3184



100S

MATCO-NORCA MODEL NUMBER	SIZE	WEIGHT
<b>100S</b>	<b>Threaded Cast Iron Gate Valve - IBBM - NRS</b>	
<b>125 SWP 200 WOG</b>		
<b>MSS SP-70 WW-V-58-CL1</b>		
<b>Bituminous Coated</b>		
<b>HANDWHEEL</b>		
100S08	2"	23
100S09	2-1/2"	25
100S10	3"	34
100S11	4"	58
100S12	5"	77
100S13	6"	111

# Cast Iron Gate Valves

## IBBM - Iron Body Bronze Mounted



105S

**105S**

**MATCO-NORCA  
MODEL NUMBER**

**SIZE**

**WEIGHT**

**Threaded Cast Iron Gate Valve - OS&Y - IBBM - Rising Stem**

**125 SWP 200 WOG  
MSS SP-70 WW-V-58-CL1  
Bituminous Coated**

105S08	2"	25
105S09	2-1/2"	27
105S10	3"	40
105S11	4"	66
105S13	6"	135

**200F**

**Flanged Cast Iron Gate Valve - IBBM - NRS**

**200 WOG - Not for Steam Service  
MSS SP-70**

**Bituminous Coated  
HANDWHEEL**



200F

200F09	2-1/2"	39
200F10	3"	47
200F11	4"	66
200F13	6"	139
200F14	8"	201
200F15	10"	295

*OP. Nuts Available. See Page 53 for Part Numbers.*

**205F**

**Flanged Cast Iron Gate Valve - OS&Y - IBBM - Rising Stem**

**200 WOG - Not for Steam Service  
MSS SP-70**

**Bituminous Coated**



205F

205F10	3"	51
205F11	4"	75
205F13	6"	141
205F14	8"	223
205F15	10"	322

# Cast Iron & Ductile Iron Gate Valves

## Cast Iron Globe Valve

Cast Iron Gate Valves  
Cast Iron Globe Valve



105W

MATCO-NORCA MODEL NUMBER	SIZE	WEIGHT
<b>105W</b>	<b>Flanged Cast Iron Gate Valve - OS&amp;Y - Resilient Wedge - Rising Stem</b>	
<b>AWWA C509 3" - 12" 200 CWP 14" - 16" 150 CWP</b>		
<b>3 Bosses - 1 Tapped &amp; Plugged</b>		
<b>Fusion Bonded Epoxy</b>		
105W10	3"	64
105W11	4"	93
105W13	6"	157
105W14	8"	269
105W15	10"	436
105W16	12"	597
105W17	14"	827
105W18	16"	1135

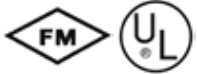

MATCO-NORCA MODEL NUMBER	SIZE	WEIGHT
<b>105U</b>	<b>Flanged Cast Iron Gate Valve - OS&amp;Y - Resilient Wedge - Rising Stem</b>	
<b>175 CWP</b>		
<b>3 Bosses - 1 Tapped &amp; Plugged N.Y.C. APPROVED USC Approved</b>		
<b>Fusion Bonded Epoxy</b>		
105U09	2-1/2"	50
105U10	3"	66
105U11	4"	97
105U13	6"	164
105U14	8"	283
105U15	10"	456
105U16	12"	754



105U



MATCO-NORCA MODEL NUMBER	SIZE	WEIGHT
<b>205U</b>	<b>Flanged Ductile Iron Gate Valve - OS&amp;Y - Resilient Wedge - Rising Stem</b>	
<b>AWWA C515 300 CWP Max. Temperature 160° F</b>		
<b>4 Bosses - 1 Tapped &amp; Plugged</b>		
<b>Fusion Bonded Epoxy Coating - AWWA C550</b>		
205U09	2-1/2"	58
205U10	3"	69
205U11	4"	104
205U13	6"	172
205U14	8"	243
205U15	10"	441
205U16	12"	684



205U

MATCO-NORCA MODEL NUMBER	SIZE	WEIGHT
<b>150F</b>	<b>Flanged Cast Iron Globe Valve - OS&amp;Y - IBBM - Rising Stem</b>	
<b>125 SWP 200 CWP</b>		
<b>MSS-SP-85</b>		
<b>Bituminous Coated</b>		
150F08	2"	38
150F09	2-1/2"	49
150F10	3"	60
150F11	4"	99
150F13	6"	187
150F14	8"	315



150F

Valves

# Cast Iron Swing Check Valves IBBM & Resilient Seat



115F

MATCO-NORCA MODEL NUMBER	SIZE	WEIGHT
<b>115F</b>	<b>Flanged Cast Iron Swing Check Valve - IBBM</b>	
<b>125 SWP 200 WOG</b>		
<b>One Boss MSS-SP-71 Bituminous Coated</b>		
115F08	2"	20
115F09	2-1/2"	31
115F10	3"	42
115F11	4"	69
115F12	5"	80
115F13	6"	115
115F14	8"	231
115F15	10"	357
115F16	12"	498



115S

<b>115S</b>	<b>Threaded Cast Iron Swing Check Valve - IBBM</b>	
<b>125 SWP 200 WOG</b>		
<b>MSS-SP-71 Bituminous Coated</b>		
115S08	2"	14
115S09	2-1/2"	18
115S10	3"	27
115S11	4"	53
115S12	5"	79



120F

<b>120F</b>	<b>Flanged Cast Iron Swing Check Valve - Resilient Seat</b>	
<b>200 CWP</b>		
<b>One Boss MSS-SP-71 Epoxy Coated</b>		
120F08	2"	20
120F09	2-1/2"	31
120F10	3"	41
120F11	4"	69
120F12	5"	79
120F13	6"	115
120F14	8"	230
120F15	10"	356
120F16	12"	497



120S

<b>120S</b>	<b>Threaded Cast Iron Swing Check Valve - Resilient Seat</b>	
<b>200 CWP</b>		
<b>MSS-SP-71 Epoxy Coated</b>		
120S08	2"	14
120S09	2-1/2"	18
120S10	3"	27
120S11	4"	53
120S13	6"	99

# Cast Iron Swing Check Valves Resilient Seat



120W

**120W**

**MATCO-NORCA  
MODEL NUMBER**

**SIZE**

**WEIGHT**

## Flanged Cast Iron Swing Check Valve - Resilient Seat

**AWWA C508 200 CWP**

**One Boss Fusion Bonded Epoxy**

120W10	3"	56
120W11	4"	75
120W13	6"	144
120W14	8"	275
120W15	10"	435
120W16	12"	594

**120WC**

## Flanged Cast Iron Check Valve - Resilient Seat - Outside Lever And Weight

**AWWA C508 3" - 12" - 200 CWP 14" - 16" - 150 CWP**

**One Boss Fusion Bonded Epoxy**



120WC

120WC10	3"	57
120WC11	4"	84
120WC13	6"	156
120WC14	8"	294
120WC15	10"	466
120WC16	12"	627
120WC17	14"	873
120WC18	16"	1025



P120WSK

*P120WSK Spring Kit Available For 120WC.*

*P120WLW Replacement Lever & Weight Available for 120WC.*

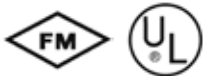

**120U**

## Flanged Cast Iron Swing Check Valve - Resilient Seat

**175 CWP**

**One Boss N.Y.C. Approved  
Fusion Bonded Epoxy**



120U

MODEL NUMBER	SIZE	Drain On Bottom	WEIGHT
120U09	2-1/2"	1/2"	44
120U10	3"	1/2"	51
120U11	4"	1/2"	79
120U13	6"	3/4"	152
120U14	8"	1"	312
120U15	10"	1"	462
120U16	12"	1"	662

Cast Iron Check  
Valves

# Wafer Style Check Valves

Cast Iron Check Valves



CVC

MATCO-NORCA MODEL NUMBER	SIZE	WEIGHT
<b>CVC</b>	<b>Wafer Check Valve - Double Bronze Disc - BUNA-N Seat</b>	
	<b>Class 125 200 WOG</b>	
	<b>Cast Iron Body - SS Springs &amp; Shaft</b>	
CVC - 2	2"	4
CVC - 2.5	2-1/2"	5
CVC - 3	3"	8
CVC - 4	4"	13
CVC - 5	5"	16
CVC - 6	6"	20
CVC - 8	8"	38
CVC - 10	10"	57
CVC - 12	12"	92
CVC - 14	14"	121
CVC - 16	16"	165



SC

MATCO-NORCA MODEL NUMBER	SIZE	WEIGHT
<b>SC</b>	<b>Silent Wafer Check Valve - Poppet Style - Bronze Disc And Seat</b>	
	<b>Class 125 200 WOG</b>	
	<b>Cast Iron Body - SS Spring</b>	
SC-2	2"	7
SC-2.5	2-1/2"	9
SC-3	3"	15
SC-4	4"	25
SC-5	5"	32
SC-6	6"	56
SC-8	8"	100
SC-10	10"	140
SC-12	12"	340

# Cast Iron Y Strainers



140F

**MATCO-NORCA  
MODEL NUMBER**

**SIZE**

**WEIGHT**

**140F**

## Flanged Cast Iron Y Strainer

**125 SWP 200 WOG  
Bituminous Coated**

140F08	2"	20
140F09	2-1/2"	31
140F10	3"	42
140F11	4"	73
140F12	5"	107
140F13	6"	121
140F14	8"	198
140F15	10"	372
140F16	12"	539

**140S**

## Threaded Cast Iron Y Strainer

**250 SWP  
Bituminous Coated**



140S

140S01	1/4"	1
140S02	3/8"	1
140S03	1/2"	1
140S04	3/4"	2
140S05	1"	3
140S06	1-1/4"	5
140S07	1-1/2"	7
140S08	2"	12
140S09	2-1/2"	27
140S10	3"	38

# Cast Iron Flanges: Companion, Reducing, Blind, PVC Van Stone Flanges

**MATCO-NORCA  
MODEL NUMBER**

**CICF**

**Cast Iron Companion Flange**



CICFB



CICFG

Black	Galv.	Flange x O.D.	# Of Holes	Weight
CICFB07	CICFG07	1-1/2" x 5"	4	3
CICFB08	CICFG08	2" x 6"	4	4
CICFB09	CICFG09	2-1/2" x 7"	4	6
CICFB10	CICFG10	3" x 7-1/2"	4	8
CICFB11	CICFG11	4" x 9"	8	12
CICFB12	CICFG12	5" x 10"	8	14
CICFB13	CICFG13	6" x 11"	8	17
CICFB14	CICFG14	8" x 13-1/2"	8	26
CICFB15	CICFG15	10" x 16"	12	38
CICFB16	CICFG16	12" x 19"	12	57

**MATCO-NORCA  
MODEL NUMBER**

**CIRF**

**Cast Iron Reducing Flange**



CIRFB



CIRFG

Black	Galv.	Flange x IPS	IPS x O.D.	# Of Holes	Weight
CIRFB32	CIRFG32	3" x 2"	2" x 7-1/2"	4	9
CIRFB42	CIRFG42	4" x 2"	2" x 9"	8	14
CIRFB43	CIRFG43	4" x 3"	3" x 9"	8	13
CIRFB54	CIRFG54	5" x 4"	4" x 10"	8	16
CIRFB62	CIRFG62	6" x 2"	2" x 11"	8	26
CIRFB63	CIRFG63	6" x 3"	3" x 11"	8	23
CIRFB64	CIRFG64	6" x 4"	4" x 11"	8	21
CIRFB65	CIRFG65	6" x 5"	5" x 11"	8	19
CIRFB82	CIRFG82	8" x 2"	2" x 13-1/2"	8	44
CIRFB83	CIRFG83	8" x 3"	3" x 13-1/2"	8	40
CIRFB84	CIRFG84	8" x 4"	4" x 13-1/2"	8	37
CIRFB85	CIRFG85	8" x 5"	5" x 13-1/2"	8	34
CIRFB86	CIRFG86	8" x 6"	6" x 13-1/2"	8	31

**CIBF**

**Cast Iron Blind Flange**



CIBF

Black	Nominal Size	Flange x O.D.	# Of Holes	Weight
CIBFB08	2"	2" x 6"	4	5
CIBFB09	2-1/2"	2-1/2" x 7"	4	7
CIBFB10	3"	3" x 7-1/2"	4	9
CIBFB11	4"	4" x 9"	8	16
CIBFB13	6"	6" x 11"	8	25
CIBFB14	8"	8" x 13-1/2"	8	42
CIBFB15	10"	10" x 16"	12	65
CIBFB16	12"	12" x 19"	12	85

**PVCF**

**PVC Van Stone Flange - (Sch 80)  
Socket (Swivel)**



PVCF

		# Of Holes	Weight
PVCF08	2"	4	1
PVCF10	3"	4	2
PVCF11	4"	8	3
PVCF12	5"	8	4
PVCF13	6"	8	4
PVCF14	8"	8	6
PVCF15	10"	12	11
PVCF16	12"	12	20



# Accessories: Gaskets, Bolts & Bolt & Gasket Sets

Accessories

**MATCO-NORCA  
MODEL NUMBER**

**SIZE**

**GSNA/GNA 150# Non-Asbestos Ring Bolt Pack - 1/16"**

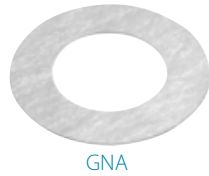

GSNA

GNA

**Gasket Only**

GSNAG2	GNA2	2"
GSNAG2.5	GNA2.5	2-1/2"
GSNAG3	GNA3	3"
GSNAG4	GNA4	4"
GSNAG5	GNA5	5"
GSNAG6	GNA6	6"
GSNAG8	GNA8	8"
GSNAG10	GNA10	10"
GSNAG12	GNA12	12"
GSNAG14	GNA14	14"
GSNAG16	GNA16	16"

**MATCO-NORCA  
MODEL NUMBER**

**SIZE**

**GSAFF/GFFNA 150# Non-Asbestos Full Face Bolt Pack - 1/16"**

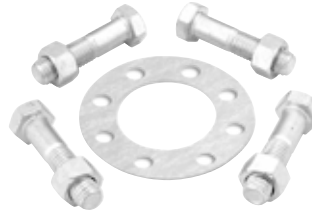

GSAFFG

GFFNA

**Gasket Only**

GSNAFFG2	GFFNA2	2"
GSNAFFG2.5	GFFNA2.5	2-1/2"
GSNAFFG3	GFFNA3	3"
GSNAFFG4	GFFNA4	4"
GSNAFFG5	GFFNA5	5"
GSNAFFG6	GFFNA6	6"
GSNAFFG8	GFFNA8	8"

**GSFF/GFF 150# Full Face Red Rubber Bolt Pack - 1/8"**

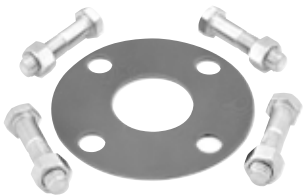

GSFF

GFF

**Gasket Only**

GSFFG2	GFF2	2"
GSFFG2.5	GFF2.5	2-1/2"
GSFFG3	GFF3	3"
GSFFG4	GFF4	4"
GSFFG5	GFF5	5"
GSFFG6	GFF6	6"
GSFFG8	GFF8	8"
GSFFG10	GFF10	10"
GSFFG12	GFF12	12"
GSFFG14	GFF14	14"
GSFFG16	GFF16	16"

**GSNAX/GNAX 300# Non-Asbestos Ring Bolt Pack - 1/16"**

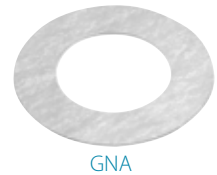

GSNA

GNA

**Gasket Only**

GSNAXG2	GNAX2	2"
GSNAXG2.5	GNAX2.5	2-1/2"
GSNAXG3	GNAX3	3"
GSNAXG4	GNAX4	4"
GSNAXG5	GNAX5	5"
GSNAXG6	GNAX6	6"
GSNAXG8	GNAX8	8"

**SBG Plated Stud Bolt, Nut And Washer Set**

**For Wafer Butterfly Valves**

	Fits Sizes	Quantity and Bolt Size
SBG2	2" & 2-1/2"	(4) 5/8" x 6"
SBG3	3"	(4) 5/8" x 7"
SBG4	4"	(8) 5/8" x 7"
SBG6	5", 6" & 8"	(8) 3/4" x 7"
SBG10	10" & 12"	(12) 7/8" x 8"
SBG14	14"	(12) 1" x 8"
SBG16	16"	(16) 1" x 10"



SBG

# Mechanical Joint Accessory Kits

## T-Wrench For Cast & Ductile Valves



100MJ

MATCO-NORCA MODEL NUMBER	SIZE	WEIGHT
<b>100MJ</b>	<b>MJ Accessory Kit - Fits Ductile Iron &amp; C-900 Pipe</b> Includes - STD T-Head Bolts, MJ Gasket & D.I. Gland	
100MJ2	2"	5
100MJ3	3"	7
100MJ4	4"	8
100MJ6	6"	12
100MJ8	8"	15
100MJ10	10"	20
100MJ12	12"	25
100MJ14	14"	25
100MJ16	16"	25



100MJX

MATCO-NORCA MODEL NUMBER	SIZE	WEIGHT
<b>100MJX</b>	<b>MJ Transition Accessory Kit - Fits (IPS) PVC &amp; Steel Pipe</b> Includes - STD T-Head Bolts, Transition Gasket & D.I. Gland	
100MJX2	2"	5
100MJX3	3"	7
100MJX4	4"	8
100MJX6	6"	12
100MJX8	8"	15
100MJX10	10"	20
100MJX12	12"	25



EMKL

MATCO-NORCA MODEL NUMBER	SIZE	WEIGHT
<b>EMKL</b>	<b>T-Wrench For 2" Operating Nut</b>	
EMKL36	36"	
EMKL60	60"	

# Wheel Handles & Operating Nuts For Iron Gate Valves

## WH Wheel Handles For Iron Gate Valves



P-2WH



P-WH-U

MATCO-NORCA MODEL #	SIZE	FITS MODEL #	SIZE	FITS MODEL #
P-WH-A	2", 2-1/2"	10RS/W/T		
P-WH-B	3"	10RS/W/T	2", 2-1/2"	100F/S
P-WH-C	4"	10RS/W/T	3"	100F/S
P-WH-D	4"	100F/S		
P-WH-E	5", 6"	10RS/W/T	5", 6"	100F/S
P-WH-F	8"	10RS/W/T	8"	100F/S
P-WH-G	10"	10RS/W/T	10"	100F
P-WH-H	12"	10RS/W/T	12"	100F
P-WH-U3	2-1/2, 3"	105U		
P-WH-U4	4"	105U		
P-WH-U6	6"	105U		
P-WH-U8	8"	105U		
P-WH-U10	10"	105U		
P-WH-U12	12"	105U		
P105FA	2"	105F/S	2", 2-1/2"	12RW
P105FB	2-1/2"	105F/S	3"	12RW
P105FC	3"	105F/S/W	4"	12RW
P105FD	4"	105F/S/W	5", 6"	12RW
P105FE	5"	105F/S		
P105FG	6"	105F/S/W		
P105FH	8"	105F/S/W		
P105FI	10"	105F/S/W		
P105FJ	12"	105F/S/W		
P-2DWH8	2"	200WD/WW/MW	2"	100RTW
P-2DWH9	2-1/2"	200WD/WW/MW	2-1/2"	100RTW
P-2DWH10	3"	200WD/WW/MW/FJW	3"	100RTW
P-2DWH11	4"	200WD/WW/MW/FJW	4"	100RTW
P-2DWH13	6"	200WD/WW/MW/FJW	6"	100RTW
P-2DWH14	8"	200WD/WW/MW/FJW	8"	100RTW
P-2DWH15	10"	200WD/WW/MW/FJW	10"	100RTW
P-2DWH16	12"	200WD/WW/MW/FJW	12"	100RTW
<b>Old Style Handwheels</b>				
P-2WH10	3"	200W/M/FJ	3"	100RT
P-2WH11	4"	200W/M/FJ	4"	100RT
P-2WH13	6"	200W/M/FJ	6"	100RT
P-2WH14	8"	200W/M/FJ	8"	100RT
P-2WH15	10"	200W/M/FJ	10"	100RT

## OP 2" Operating Nut For NRS Iron Gate Valves



P-100NB



P-100NL

MATCO-NORCA MODEL #	SIZE	FITS MODEL #	SIZE	FITS MODEL #
P-100NA	2", 2-1/2"	10RS/W/T		
P-100NB	3"	10RS/W/T	2", 2-1/2"	100F/S
P-100NC	4"	10RS/W/T	3"	100F/S
		200F		
P-100ND	4"	100F/S		
		200F		
P-100NE	5", 6"	10RS/W/T	5", 6"	100F/S
		200F		
P-100NF	8"	10RS/W/T	8"	100F/S
		200F		
P-100NG	10"	10RW	10"	100F
P-100NH	12"	10RW	12"	100F
P-100NL	14"	100W/M/F		
P-100NM	16"	100F		
P-100NO	18"	100F		
P-100NP	16"	100W/M		
P-200NK	10" - 12"	200W/M		

## OP 2" Operating Nut For NRS Iron Gate Valves



P-200DNC

P-200DNC	2" - 4"
P-200DND	6" - 8"
P-200DNF	10"
P-200DNG	12"

# Butterfly Valve Part # Breakdown

B5-RLO4

**B5** **RLO** **4** **-**

Choose Series
B1
B5
B6
B7

Select Style	
RLO	Wafer Style, Lever Operated
RWG	Wafer Style, Gear Operated
LGL	Lug Style, Lever Operated
LGG	Lug Style, Gear Operated

Part#	Size
2	2"
2.5	2-1/2"
3	3"
4	4"
5	5"
6	6"
8	8"
10	10"
12	12"
Through 36"	

Disc & Liner		Example
-	Nickel Plated Ductile Iron Disc - BUNA-N Liner	B5-RLO4
AB	Aluminum-Bronze Disc - BUNA-N Liner	B5-RLO4AB
ABE	Aluminum-Bronze Disc - EPDM Liner	B5-RLO4ABE
S	316 Stainless Steel Disc - BUNA-N Liner	B5-RLO4S
SE	316 Stainless Steel Disc - EPDM Liner	B5-RLO4SE

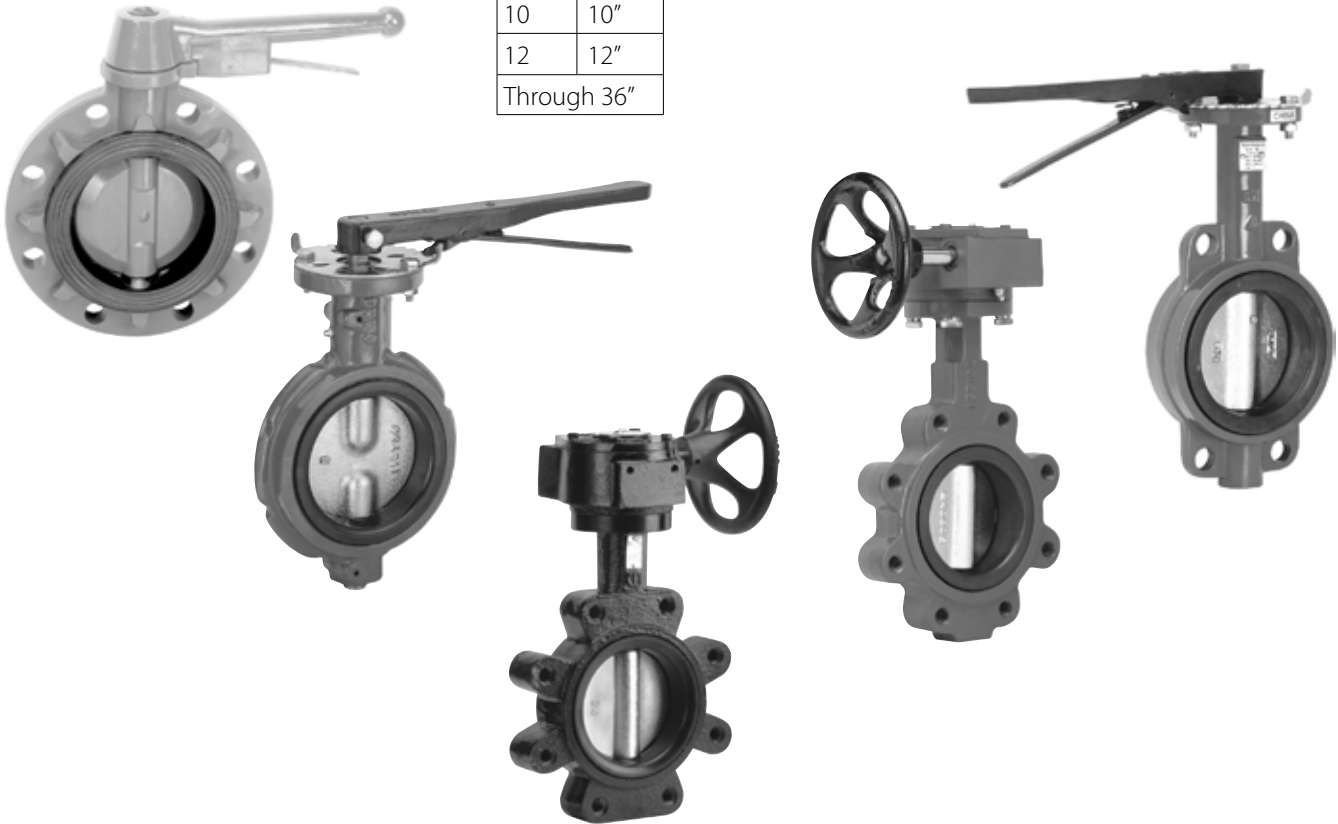

Butterfly Valve Part # Breakdown

# B1 PVC Butterfly Valves & Parts

MATCO-NORCA MODEL NUMBER		SIZE	WEIGHT
<b>B1</b>	<b>PVC Wafer Butterfly Valve - 200 PSI</b>		

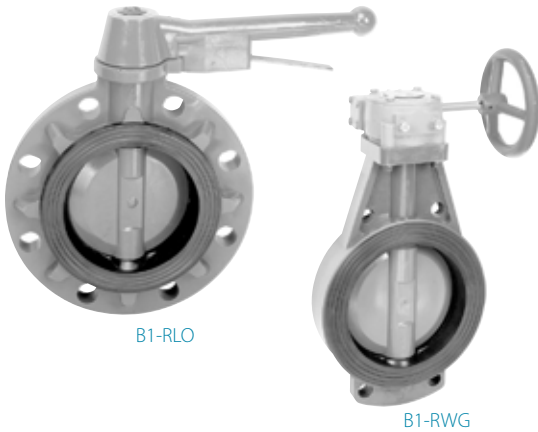

**B1-RLO 10 Position Lock Lever Operated**

B1-RLO2	2"	4
B1-RLO2.5	2-1/2"	4
B1-RLO3	3"	7
B1-RLO4	4"	8
B1-RLO6	6"	11

**B1-RWG Gear Operated**

B1-RWG8	8"	28
B1-RWG10	10"	36
B1-RWG12	12"	65

*Valves Only Available with Stainless Steel Stem, EPDM Liner, Polypropylene Disc.*

## B1 Parts

MATCO-NORCA MODEL NUMBER		SIZE	WEIGHT
<b>B1L</b>	<b>Lever Handle For B1 Butterfly Valve</b>		

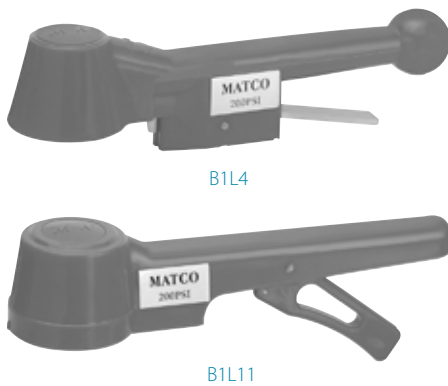

**Replacement Handles For B1 Butterfly Valve**

**Round End - Old Style**

B1L3	3"
B1L4	4"
B1L6	6"

**Square End - New Style**

B1L10	3"
B1L11	4"
B1L13	6"

B1 Butterfly Valves & Parts

# B5 Butterfly Valves

## Gear or 10 Position Lock Lever Operated

**MATCO-NORCA**  
MODEL NUMBER      SIZE      WEIGHT

**B5-RLO**      **Cast Iron Wafer Butterfly Valve - 200 PSI**



B5-RLO2	2"	9
B5-RLO2.5	2-1/2"	11
B5-RLO3	3"	12
B5-RLO4	4"	15
B5-RLO5	5"	19
B5-RLO6	6"	22
B5-RLO8	8"	39
B5-RLO10	10"	55
B5-RLO12	12"	75

**MATCO-NORCA**  
MODEL NUMBER      SIZE      WEIGHT

**B5-LGL**      **Cast Iron Lug Butterfly Valve - 200 PSI**



B5-LGL2	2"	10
B5-LGL2.5	2-1/2"	12
B5-LGL3	3"	13
B5-LGL4	4"	20
B5-LGL5	5"	24
B5-LGL6	6"	26
B5-LGL8	8"	45
B5-LGL10	10"	64
B5-LGL12	12"	86

**B5-RWG**      **Cast Iron Wafer Butterfly Valve**



**2" - 12" Valves Are Rated 200 PSI**  
**14" - 36" Valves Are Rated 150 PSI**

B5-RWG2	2"	18
B5-RWG2.5	2-1/2"	20
B5-RWG3	3"	21
B5-RWG4	4"	24
B5-RWG5	5"	29
B5-RWG6	6"	31
B5-RWG8	8"	59
B5-RWG10	10"	75
B5-RWG12	12"	102
B5-RWG14	14"	125
B5-RWG16	16"	207
B5-RWG18	18"	251
B5-RWG20	20"	349
B5-RWG24	24"	448
B5-RWG30	30"	1155
B5-RWG36	36"	1859

**B5-LGG**      **Cast Iron Lug Butterfly Valve**



**2" - 12" Valves Are Rated 200 PSI**  
**14" - 36" Valves Are Rated 150 PSI**

B5-LGG2	2"	21
B5-LGG2.5	2-1/2"	21
B5-LGG3	3"	24
B5-LGG4	4"	29
B5-LGG5	5"	33
B5-LGG6	6"	35
B5-LGG8	8"	64
B5-LGG10	10"	83
B5-LGG12	12"	113
B5-LGG14	14"	149
B5-LGG16	16"	244
B5-LGG18	18"	282
B5-LGG20	20"	374
B5-LGG24	24"	662
B5-LGG30	30"	1250
B5-LGG36	36"	2050

*Available with Nickel Plated Ductile Disc;  
Available with BUNA-N Liner; See Butterfly Valve Part # Breakdown Page 54.*

# B5 Butterfly Valve Parts & Accessories

**MATCO-NORCA MODEL NUMBER**      **SIZE**

**B5L**      **Lever Handle For B5 Butterfly Valve**



B5L3	2" - 3"
B5L4	4"
B5L6	6"
B5L8	8"
B5L10	10"
B5L12	12"

**B5IND**      **Index Plate For B5 Butterfly Valve**



**Chrome Plated**

B5IND23	2" - 3"
B5IND810	8 - 10"
B5IND12	12"

**Stainless Steel Plated**

B5IND3S	3"
B5IND4S	4"
B5IND6S	6"

**B5GRNUT**      **Gear Nut For B5 Butterfly Valve**



B5GRNUT6	2" - 6"
B5GRNUT12	8" - 12"
B5GRNUT14	14"
B5GRNUT16	16"
B5GRNUT18	18"
B5GRNUT20	20"
B5GRNUT24	24"

**MATCO-NORCA MODEL NUMBER**      **SIZE**      **MATCO-NORCA MODEL NUMBER**      **SIZE**

**B5G**      **Gear For B5 Butterfly Valve**



**With Handwheel & Pin**

B5G23	2" - 3"	B5G14	14"
B5G4	4"	B5G16	16"
B5G56	5" - 6"	B5G18	18"
B5G8	8"	B5G24	24"
B5G10	10"		
B5G12	12"		
B5G12R	12" Rounded		

**B5WH**      **Hand Wheel For B5 Butterfly Valve**



B5-WH2	2" - 6"
B5-WH8	8" - 12"
B5-WH16	16"
B5-WH18	18"
B5-WH30	30"
B5-WH36	36"

**B5X**      **Stem Extension For B5 Butterfly Valve**



	<b>Fits Valve Size</b>	<b>Length of Extension</b>
B5-X** A	2" - 3"	24"
B5-X** B	4"	36"
B5-X** C	5" - 6"	48"
B5-X** D	8"	60"
B5-X** E	10"	72"
B5-X** F	12"	
B5-X** G	14"	
B5-X** H	16"	
B5-X** I	18"	
B5-X** J	20"	
B5-X** K	24"	

**Example: B5-X24-A=**

24" Extension For  
2" - 3" Butterfly Valve

**\*\*Place Holder For Length of Extension.  
Flat & Round Extensions Also Available.**

**B5LCH**      **Latch Nut For B5 Butterfly Valve**



B5-LCH-3	2" - 3"
B5-LCH-4	4"
B5-LCH-6	6"

# B6 Butterfly Valves

## Gear or 10 Position Lock Lever Operated

**MATCO-NORCA  
MODEL NUMBER**

**SIZE**

**WEIGHT**

**B6-RLO**

**Cast Iron Wafer Butterfly Valve - 200 PSI**



B6-RLO

B6-RLO2	2"	7
B6-RLO2.5	2-1/2"	9
B6-RLO3	3"	10
B6-RLO4	4"	13
B6-RLO5	5"	17
B6-RLO6	6"	19
B6-RLO8	8"	31
B6-RLO10	10"	45
B6-RLO12	12"	74

**MATCO-NORCA  
MODEL NUMBER**

**SIZE**

**WEIGHT**

**B6-LGL**

**Cast Iron Lug Butterfly Valve - 200 PSI**



B6-LGL

B6-LGL2	2"	10
B6-LGL2.5	2-1/2"	11
B6-LGL3	3"	13
B6-LGL4	4"	22
B6-LGL5	5"	26
B6-LGL6	6"	33
B6-LGL8	8"	42
B6-LGL10	10"	63
B6-LGL12	12"	92

**B6 Butterfly  
Valves**

**B6-RWG**

**Cast Iron Wafer Butterfly Valve - 200 PSI**



B6-RWG

B6-RWG2	2"	17
B6-RWG2.5	2-1/2"	18
B6-RWG3	3"	19
B6-RWG4	4"	22
B6-RWG5	5"	27
B6-RWG6	6"	29
B6-RWG8	8"	55
B6-RWG10	10"	68
B6-RWG12	12"	101

**B6-LGG**

**Cast Iron Lug Butterfly Valve - 200 PSI**



B6-LGG

B6-LGG2	2"	20
B6-LGG2.5	2-1/2"	21
B6-LGG3	3"	22
B6-LGG4	4"	31
B6-LGG5	5"	36
B6-LGG6	6"	43
B6-LGG8	8"	63
B6-LGG10	10"	86
B6-LGG12	12"	118

*Valves Only Come With Stainless Steel Stem, BUNA-N Seat, Ductile Disc.*



# B6 Butterfly Valve Parts

## B7 Butterfly Valve

**MATCO-NORCA  
MODEL NUMBER**

**SIZE**

**B6L**

**Lever Handle For B6 Butterfly Valve**



B6L3	2" - 3"
B6L4	4"
B6L6	6"
B6L8	8"
B6L10	10"
B6L12	12"

**MATCO-NORCA  
MODEL NUMBER**

**SIZE**

**B6G**

**Gear For B6 Butterfly Valve**



**With Handwheel & Pin**

B6G23	2" - 3"
B6G4	4"
B6G56	5 - 6"
B6G8	8"
B6G10	10"
B6G12	12"

**B6IND**

**Index Plate For B6 Butterfly Valve**



B6IND26	2" - 6"
B6IND812	8" - 12"

## B7 Butterfly Valve

**MATCO-NORCA  
MODEL NUMBER**

**SIZE**

**WEIGHT**

**B7**

**Cast Iron Wafer Butterfly Valve - Double Stem - 200 PSI - Short Neck**



B7-RLO

B7-RLO2	2"	8
B7-RLO2.5	2-1/2"	10
B7-RLO3	3"	11
B7-RLO4	4"	15
B7-RLO5	5"	20
B7-RLO6	6"	22
B7-RLO8	8"	36
B7-RLO10	10"	51
B7-RLO12	12"	71

*Available With Stainless Steel Stem, BUNA-N Liner, Ductile Disc or Aluminum Bronze Disc.*

# Terms & Conditions Of Sale

## Acceptance

Orders, whether verbal or written, are subject to acceptance by Matco-Norca, Inc. Hereinafter referred to as the seller at its Brewster, N.Y. office. No terms or conditions of buyers order contrary to seller's terms and conditions shall be binding upon seller unless specifically agreed upon by seller in writing. Sellers acceptance of orders shall occur by written acknowledgement or tender of delivery of goods and or services the subject hereof (goods), which ever occurs first.

## Prices And Sales Policy

Until written confirmation of this contract has been received by buyer, all prices are subject to change without prior notice. We reserve the right to adjust orders to standard package quantities unless otherwise stated on buyers purchase order. We reserve the right to make product improvement without notice. If seller determines buyer's credit is unsatisfactory or there is reasonable doubt concerning buyer's ability to pay, payment in advance may be required or buyer shall provide security for such payment in an amount and form acceptable to seller. Unless otherwise specified by seller, terms are 2% 10 days/net 30 days.

Cash discounts apply to the value of goods at the net invoiced value before transportation charges, taxes and additional duties. Unearned cash discounts will be charged back as an unpaid balance to the buyers account. Any past due amount is subject to a finance charge of 1-1/2% per month (18% per year) on the total past due balance in accordance with the Truth-in-lending Act in Title 1 of the Federal Consumer Protection Act effective July 1, 1969.

## Taxes

All prices are exclusive of taxes and excises. Sales, use and other taxes, by whomsoever levied, are to be paid by the buyer and unless invoiced, are to be paid by buyer direct to the appropriate governmental agency. Buyers are required to furnish seller with a copy of their tax exemption of resale certificate, otherwise applicable state sales taxes will be charged.

## Delivery And Shipment Of Materials

All goods are sold F.O.B. sellers warehouse. Delivery of material to a common carrier shall constitute delivery thereof to buyer and risk of loss shall pass to buyer at such time. Claims for damage to or loss of material in transit shall be filed by buyer direct with carrier. Buyer assumes all risks and liability for the results obtained by the use of material delivered hereunder. No claim of any kind, whether as to material delivered or for nondelivery or late delivery of material and whether based on negligence or otherwise, shall be greater in amount than the purchase price of the material in respect to which such claim is made. In no event shall seller be liable for indirect or consequential damages or for anticipated profits or loss of use of equipment.

## Returns And Cancellations

Permission in writing and return authorization must be obtained from seller before any goods are returned. All returns must be prepaid, no collect shipments will be accepted. All returns made for reasons other than defects are subject to a restocking charge. Discontinued goods are not returnable.

Cancellation of orders may be made only with the sellers written consent and shall be subject to cancellation charges.

## Governing law

The entering into, construction, interpretation, performance and discharge of the terms set forth herewith shall be governed in accordance with the laws of the State of New York.

## Limited One Year Warranty

Seller warrants the material to be free of defects in material and workmanship, under normal use, proper maintenance and proper operation, for a period of one year from date of delivery to a common carrier for shipment to buyer or his designated agent. The obligation of the seller is limited to (1) repair of the material, or (2) replacement of any component or components proven defective in material or workmanship, or (3) refund of the purchase price. Seller shall have no liability for the cost of removal or reinstallation with respect to any replaced or repaired product. The election of said remedies shall be determined by seller in its sole discretion and shall be considered final disposition.

All implied warranties, including the implied warranties of merchantability and fitness for a particular purpose, are hereby disclaimed and excluded. This warranty is in lieu of all other warranties, guarantees, agreements and similar obligations or seller, in no event shall seller be liable for consequential or incidental damages.

## Claims

No later than ten (10) days from receipt of material buyer will report, in writing, all claims for any damage, defects or shortages. All claims, including for alleged damaged or defective material, shortage negligence or any other cause whatsoever "(defective performance)", shall deemed waived unless made in writing within the ten (10) day period. However, any defective performance not discoverable within said ten (10) day period (including that discoverable only in processing or in further manufacturing) shall be deemed waived unless made in writing and received by seller in writing within ninety (90) days after receipt or within ten (10) days after buyer learns of the alleged defect, whichever occurs first. Seller's liability shall in no event exceed the purchase price of the material in respect to which the claim is made, or at the election of seller at its sole discretion, and to repair or replacement of such material. Seller shall not be liable for, and buyer assumes all responsibility for, all personal injury and property damage resulting from handling, possession, use or resale of the material by buyer. In no event shall seller be liable for incidental or consequential damages, whether buyer's claim is in contract, negligence, or otherwise. If claim is made, buyer shall permit seller at seller's option to re-inspect the material at buyer's plant or if seller so directs, buyer shall return the material at buyer's expense to seller's facility for re-inspection. No material may be returned to seller without prior written permission from seller.

## Force Majeure

Anything in this agreement to the contrary notwithstanding, it is expressly agreed that seller shall not be liable for any damages resulting from, and buyer shall not have the right to cancel this order because of any delays caused in whole or in part by fires, floods, windstorms, tornadoes, wars, riots, insurrections, strikes, lockouts sit-downs, slow-downs, or other labor trouble, causing cessation or interruption of operation or by accident, material shortages, labor or fuel shortages, or inability to procure labor or materials, either on the part of the seller, or because any plant, plants or any portion thereof belonging to seller have been commandeered by the legally constituted public authority, or because of any priorities or preferences established for the manufacture, assembly or allotment of materials by order, decree, or to otherwise of the united states, or by any department, bureau, commission, committee, agent or administrator of any legally constituted public authority in any plant of seller, or any of its suppliers, or resulting from any other cause beyond the control of seller.

# Quick Find Index

## ITEM NAME PAGE NUMBER

<b>10</b>	
10RS	47
10RT	47
10RW	47
15SSTH	39
<b>20</b>	
20CSFLD	39
20SSFLD	39
20SSTHM	40
25CSTHM	40
25SSTHM	40
26LF	32
29LF	31
<b>30</b>	
30CSSW	42
30CSSWM	42
30CSTH	42
30CSTHM	42
30SSSW	41
30SSSWM	41
30SSTH	41
30SSTHM	41
<b>40</b>	
40SSTH	43
<b>50</b>	
50SSTH	43
58	8,9
59	8
59DB	34
<b>60</b>	
60SSTH	43
<b>70</b>	
70SSTH	43
<b>100</b>	
100F	49
100M	46
100MJ	58
100MJX	58
100S	49
100W	46
105F	49
105S	50
105U	51
105W	51
115F	52
115S	52
120F	52
120S	52
120U	53
120W	53
120WC	53
140F	55

## ITEM NAME PAGE NUMBER

140S	55
145	16
150F	51
<b>200</b>	
200AL	15
200F	50
200FJW	46
200L	15
200LF	15
200MD	48
200MW	46
200RTD	48
200TVD	48
200WD	48
200WW	46
201	20
201A	20
201CMLF	20
202CMLF	20
202LF	20
203	27
204	21
205	21
205CM	21
205F	21, 50
205U	51
205WH	30
206	27
206H	27
206HLK	27
206VB	27
207	25
209	28
209PX	28
212	28
212PX	28
240H	15
240T	15
<b>300</b>	
300BV	6
<b>400</b>	
434LF	33
<b>500</b>	
501	13
503	12
511	13
512	13
513	13
514	12
517	12
519	14
519TP	14
521	17
521N	17
523	19

## ITEM NAME PAGE NUMBER

525	18
527LF	18
529	19
530	17
532	18
<b>600</b>	
646AS	22
646BV	25
646R	25
<b>700</b>	
730	14
752CMP	7
752N	6
752UF	7
754D	7
754N	6
754PXDEL	7
754PXL	7
755	5
755MF	7
757	4
758	5
759	4
759MF	4
759PLF	5
759SDS	34
760	5
770	10
770G	10
770N	10
771	11
772	11
772ST	11
773	11
<b>A</b>	
ADJ	30
AHV	30
AVA	30
AVS	30
AZ203	22
AZ205	22
AZ206	23
AZ207	24
AZ646	22
<b>B</b>	
B1	61
B5	62-63
B6	64-65
B7	65
BARV	29
BARVY	29
BCV	29
BFPLF	22
BSGV	29

## ITEM NAME PAGE NUMBER

<b>C</b>	
CIBF	56
CICF	56
CIF	34
CIRF	56
CK	30
CVC	54
<b>D</b>	
DCVLF	22
<b>E</b>	
EFV	33
EMKL	58
<b>F</b>	
FR	33
FV	33
FY	26
<b>G</b>	
GFF	57
GFFNA	57
GNA	57
GNAX	57
GSFF	57
GSNA	57
GSNAFF	57
GSNAX	57
<b>K</b>	
KEY	30
<b>N</b>	
NT	29
<b>O</b>	
OP	59
OTV	34
<b>P</b>	
PBVC	34
PVCF	56
<b>S</b>	
SBG	57
SC	54
SGV	29
<b>W</b>	
WH	59



# MATCO-NORCA

**Global sourcing. National compliance. Local service.**

[www.matco-norca.com](http://www.matco-norca.com)

**CALIFORNIA**

Toll Free: 866-532-8306  
Fax: 866-532-8307

**TEXAS**

Toll Free: 800-935-5456  
Fax: 713-680-2999

**NEW YORK**

Toll Free: 800-431-2082  
Fax: 845-278-9056